

Switched-mode and uninterruptible power supplies, and electronic fuses Catalogue 2014/2015

Let's connect.

Power supply



Dear Customers,

The PDF versions of our catalogues offer practical additional functions, helping you to find your way around our product range and simplifying the ordering process.

In addition to the catalogue, the PDF also contains:

- Internal page links
- Links to the online catalogue

Try it out for yourself. Click the order number to obtain more detailed information and close-up images via you web browser. The links in the PDF file also enable you to go directly to the next desired catalogue page.

Further Weidmüller product catalogues can be accessed by clicking the following:



Switch-Mode and Uninterruptible Power Supplies, Electronic Fuses

Catalogue 4.3

Switch-Mode and Uninterruptible Power Supplies, Electronic Fuses

Switch-mode power supplies

Uninterruptible power supplies (UPS)

Fuse protection for 24 V DC circuits

Unregulated power supplies

Electrical cabinet socket outlet

Appendix

Glossary/Technical appendix

Index

Index Type / Index Order No.
Addresses worldwide

Power supplies – Overview

connectPower 1ph PROeco



- Single-phase switched-mode power supply modules
- Slim design
- Large temperature range from -25 °C to 70 °C
- Three-coloured LED indicators for simple error detection
- Advanced visual warning at 90 % rated output current
- International approvals

connectPower 3ph PROeco



- 3-phase switched-mode power supply modules
- Slim design
- Large temperature range from -25 °C to 70 °C
- Three-coloured LED indicators for simple error detection
- Advanced visual warning at 90 % rated output current
- International approvals

connectPower PROeco diode modules



- Diode module for 100 % decoupling of switched-mode power supply modules
- Optimum doubling of output power
- Redundancy operation
- Up to 40 A output current can be set
- International approvals

connectPower 1ph PRO-M



- Single-phase switched-mode power supply modules
- Very slim design
- High degree of efficiency
- Power category 70...1,000 W
- Up to five devices can be connected in parallel without a diode module
- International approvals

connectPower 3ph PRO-M



- 3-phase switched-mode power supply modules
- Very slim design
- High degree of efficiency
- Power category 120...1,000 W
- Up to five devices can be connected in parallel without a diode module
- International approvals

connectPower PRO-M Extension modules



- Capacity module for increasing the peak current
- Diode modules for redundant construction
- Relay module for monitoring the output voltage

connectPower PRO-M Application solutions



- Wide-range input
85...264 V AC
80...430 V DC
- Alarm relay
- Metal snap-on foot
- International approvals

connectPower 1ph PRO-H



- Single-phase switched-mode power supplies
- High MTBF values
- Cl. I Div. 2 + ATEX
- Performance class: 70 to 600 W
- Output: 12, 24, 36 and 48 V DC

connectPower PRO-H Multi-phase



- Multi-phase switched-mode power supplies
- 85...132 / 187...550 V AC
- UL approval
- Performance class: 180 to 600 W

connectPower PRO-H Redundancy modules



- 15 A or 25 A
- 100 % load sharing
- Remote On/Off
- International approvals
- Cl. I Div. 2 + ATEX

connectPower PRO-E



- Wall mounting
- Flat design
- Metal housing
- Performance classes from 25 W to 350 W
- Universal input and output voltages

connectPower 1ph INSTAPOWERS



- Single-phase switched-mode power supply modules for the distribution board
- Compact form
- Power category 24 and 48 W
- Universal input and output voltage 5...48 V
- International approvals

connectPower 1ph WAVEPOWER



- Single-phase switched-mode power supply unit
- Slim design 22.5 mm
- Power category 12 W
- International approvals

connectPower DC/DC converters



- Compact form
- Metal housing
- Universal input and output voltage of 5 V to 48 V
- International approvals

connectPower UPS control unit



- Two 24 V models in 10 A/20 A and 40 A
- Temperature-compensated charging feature, for a long battery life
- Integrated battery diagnostics including continuous availability test
- Status relay and additional transistor outputs for remote monitoring
- Convenient LED displays for easy error analysis

connectPower battery module



- Maintenance-free, lead-acid batteries from 1.3 Ah to 17 Ah
- Integrated temperature sensor for optimal battery charging
- Integrated fuse for reliable activation
- Support capacity up to 40 A / 30 min or 10 A / 90 min
- Robust metal housing for wall mounting

connectPower buffer module



- Maintenance-free UPS on a capacitor basis, with a capacity to support 20 A / 200 ms
- Parallel switching to increase the output current or support time
- Status notification via LED and relay contact

compactPower 1ph unregulated power supplies



- Single-phase unregulated power supplies
- Compact form
- Standard voltage ~230/400 V to IEC 38 +/- 15 V tap
- Reliable short-circuit and overload protection

Power supplies – Overview

compactPower 3ph unregulated power supplies



- 3-phase unregulated power supplies
- Compact form
- Nominal voltage to IEC 38 +/- 5 V tap
- Reliable short-circuit and overload protection

WAVEGUARD



- Electronic fusing
- Visual fault indication and potential-free contact
- Reset input
- Compact form

Electrical cabinet socket outlet



- Simple installation in electrical cabinet
- TS 35 module can be rail mounted
- VDE mark of conformity
- Two-pole with earthing contact

Power supplies – Selection

PROeco

Mains 1ph Input voltage 85...265 V AC, 80...370 V DC Input frequency 50 / 60 Hz CE, TÜV, cULus					
Output voltage	24 V	24 V	24 V	24 V	24 V
Output current	3 A	5 A	10 A	20 A	40 A
Order No.	1469470000	1469480000	1469490000	1469510000	1469520000
Page	A.5	A.5	A.6	A.6	A.7

PROeco

Mains 3ph Input voltage 3 x 340...575 V AC, Input frequency 50 / 60 Hz CE, TÜV, cULus				
Output voltage	24 V	24 V	24 V	24 V
Output current	5 A	10 A	20 A	40 A
Order No.	1469530000	1469540000	1469550000	1469560000
Page	A.8	A.8	A.9	A.9

PROeco diode modules

40 V DC max. CE, cURus, cULus; GOST		
Output voltage	40 V	40 V
Output current	2 x 10 A	2 x 20 A
Order No.	8710620000	8768650000
Page	A.10	A.10

PRO-M

Mains 1ph Input voltage 85...265 V AC, 80...370 V DC Input frequency 50 / 60 Hz CE, cURus, cULus; C-Tick, GL						
	Output voltage	24 V	24 V	24 V	24 V	24 V
	Output current	3 A	5 A	7.5 A	10 A	20 A
	Order No.	8951330000	8951340000	8951350000	8951360000	8951370000
	Page	A.13	A.13	A.14	A.14	A.15

PRO-M

Mains 1ph / 3ph Input voltage 85...265 V AC, 120...300 V DC Input frequency 50 / 60 Hz CE, cURus, cULus; C-Tick						
	Output voltage	1ph / 24 V	3ph / 24 V	3ph / 24 V	3ph / 24 V	3ph / 24 V
	Output current	40 A	5 A	10 A	20 A	40 A
	Order No.	8951380000	8951390000	8951400000	8951410000	8951420000
	Page	A.15	A.16	A.16	A.17	A.17

PRO-M expansion modules

Mains 1ph Input voltage 85...265 V AC, 80...430 V DC, Input frequency 50 / 60 Hz CE, cURus, cULus; C-Tick, GL (Depending on model)					
	Output voltage	Diode module	Diode module	Relay module	Capacity module
	Output current	20 A	40 A		
	Order No.	1222210000	1222220000	1222230000	1222240000
	Page	A.19	A.19	A.20	A.21

Power supplies – Selection

PRO-M application solutions

Mains 1ph Input voltage 85...265 V AC, 80...370 V DC, Input frequency 50 / 60 Hz CE, cURus, cULus; C-Tick, GL (Depending on model)		
	DC input voltage up to 430 V	
Output voltage	24 V	36 V
Output current	10 A	13.5 A
Order No.	1165480010	1412540010
Page	A.23	A.18



PRO-H

Mains 1ph Input voltage 85...264 V AC, 85...132/187...265 V AC (Depending on model) Input frequency 50 / 60 Hz CE; UL; CSA; Class I Div.2; ATEX Zone 2 (Depending on model)						
	Output voltage	12 V	12 V	24 V	24 V	24 V
Output current	6 A	12 A	3.8 A	3.8 A (CL 2)	7.5 A	15 A
Order No.	1105430000	1105440000	1105790000	1194410000	1105810000	1105820000
Page	A.27	A.27	A.28	A.28	A.29	A.29

PRO-H

Mains 1ph Input voltage 85...264 V AC, 85...132/187...265 V AC (Depending on model) Input frequency 50 / 60 Hz CE; UL; CSA; Class I Div.2; ATEX Zone 2 (Depending on model)					
	Output voltage	24 V	48 V	48 V	48 V
Output current	25 A	2 A	4 A	7.5 A	12.5 A
Order No.	1105840000	1194420000	1105850000	1105860000	1105870000
Page	A.30	A.31	A.31	A.32	A.32





PRO-H redundancy module

24 V DC CE, UL, UR, Class I Div.2; ATEX		
	Output voltage	24 V
Output current	15 A	20 A
Order No.	1105880000	1105890000
Page	A.35	A.35

PRO-H

Mains 1ph/2ph Input voltage 400...500 V AC, 100...500 V AC (Depending on model) Input frequency 50 / 60 Hz CE; UL; UR;			
	Similar to illustration	Similar to illustration	Similar to illustration
Rated input voltage	100...500 V AC	100...500 V AC	100...500 V AC
Output voltage	24 V	24 V	24 V
Output current	7.5 A	15 A	25 A
Order No.	1194480000	1194490000	1194310000
Page	A.33	A.33	A.34

INSTAPOW

Mains 1ph Input voltage 85...265 V AC, 120...300 V DC, 110...370 V DC (Depending on model) Input frequency 50 / 60 Hz CE, cURus, cULus;				
		class 2		class 2
Output voltage	5 V	5 V	12 V	12 V
Output current	2 A	5 A	1.5 A	4 A
Order No.	9928890005	8754960000	9928890012	8754970000
Page	A.58	A.59	A.57	A.60

Power supplies – Selection

INSTAPOWERR

Mains 1ph Input voltage 85...265 V AC, 120...300 V DC, 110... 370 V DC Input frequency 50 / 60 Hz CE, cURus, cULus (Depending on model)						
			class 2		class 2	
	Output voltage	15 V	24 V	24 V	28 V	48 V
	Output current	1.5 A	1 A	2 A	1 A	1 A
	Order No.	9928890015	9928890024	8739140000	9928890028	8879230000
Page	A.57	A.56	A.61	A.56	A.62	

WAVEPOWER

Mains 1ph 85...264 V AC 120...300 V DC CE, UL, CSA		
	Output voltage	24 V
	Output current	0.5 A
	Order No.	9918840024
	Page	A.64

connectPower DC/DC converter

Input voltage 9...16 V DC CE, UL / UR, CSA, Class 1, Div.2				
	Output voltage	12 V	15 V	24 V
	Output current	3 A	3 A	2 A
	Order No.	9919371212	9919371215	9919371224
	Page	A.66	A.67	A.67

connectPower DC/DC converter

Input voltage 18...30 V DC CE, UL / UR, CSA, Class 1, Div.2					
	Output voltage	5 V	12 V	15 V	24 V
Output current	8 A	3 A	3 A	2 A	10 A
Order No.	9919372405	9919372412	9919372415	9919372424	1313320010
Page	A.68	A.67	A.68	A.66	A.71

PRO-E





Output voltage	5 V	5 V	5 V	5 V
Output current	5 A	10 A	12 A	16 A
Order No.	1202640000	1202590000	1202470000	1165820000
Page	A.40	A.42	A.44	A.46
Output voltage	12 V	12 V	12 V	12 V
Output current	2.1 A	4.2 A	6 A	8.5 A
Order No.	1202630000	1202580000	1202480000	1165830000
Page	A.40	A.42	A.44	A.46

PRO-E

Output voltage	24 V	24 V	24 V	24 V
Output current	1.1 A	2.2 A	3.2 A	4.5 A
Order No.	1202620000	1202450000	1202490000	1165840000
Page	A.41	A.43	A.45	A.47
Output voltage	48 V	48 V	48 V	48 V
Output current	0.57 A	1.1 A	1.6 A	2.3 A
Order No.	1202610000	1202460000	1202510000	1165850000
Page	A.41	A.43	A.45	A.47

Power supplies – Selection

PRO-E

					
Output voltage	12 V	12 V	24 V	24 V	24 V
Output current	12.5 A	21 A	6.5 A	10.5 A	14.6 A
Order No.	1165870000	1202520000	1165880000	1202530000	1202550000
Page	A.48	A.50	A.48	A.50	A.52
Output voltage			48 V	48 V	48 V
Output current			3.3 A	5.2 A	7.3 A
Order No.			1165890000	1202540000	1202560000
Page			A.49	A.51	A.52

UPS control unit

Input voltage 20 ... 30 V DC		
CE, TÜV, cURus*, cULus*, GL*		
* in preparation		
Output voltage	24 V	24 V
Output current	max. 24 A	max. 48 A
Order No.	1370050010	1370040010
Page	B.5	B.5

Buffer module

Input voltage 22.5 ... 30 V DC	
CE, TÜV, cURus, cULus, GL*	
* in preparation	
Output voltage	24 V DC
Output current	max. 22 A
Order No.	1251220000
Page	B.8

Battery module

					
Rated voltage	24 V DC	24 V DC	24 V DC	24 V DC	24 V DC
Nominal capacity	1.3 Ah	3.4 Ah	7.2 Ah	12 Ah	17 Ah
Order No.	1406930000	1251070000	1251080000	1251090000	1251110000
Page	B.6	B.6	B.7	B.7	B.7

WAVEGUARD

with tension clamp connection					
	Rated voltage 24 V DC				
	CE, cURus				
Output voltage	24 V	24 V	24 V	24 V	24 V
Output current	1.6 A	3.15 A	6.3 A	8 A	0.5...5 A
Order No.	8618890000	8618910000	8618930000	8618940000	8710270000
Page	C.4	C.4	C.5	C.5	C.6

WAVEGUARD

with tension clamp connection					
	Rated voltage 24 V DC				
	CE, cURus				
Output voltage	24 V	24 V	24 V	24 V	24 V
Output current	1.6 A	3.15 A	6.3 A	8 A	0.5...5 A
Order No.	8621040000	8621030000	8621020000	8621010000	8727630000
Page	C.4	C.4	C.5	C.5	C.6

compactPower 1ph unregulated power supplies

Mains 1ph						
	Input voltage 230 V / 400 V ± 15 V					
	Input frequency 50 / 60 Hz					
	CE, cURus, cULus					
Output voltage	24 V	24 V	24 V	24 V	24 V	24 V
Output current	1.5 A	3 A	6 A	8 A	11 A	18 A
Order No.	8575260000	8575270000	8575280000	8575300000	8575310000	8575320000
Page	D.4	D.4	D.6	D.8	D.6	D.6

Power supplies – Selection

compactPower 3ph unregulated power supplies

Mains 3ph Input voltage 3x 400 V ± 5 % Input frequency 50 / 60 Hz CE, cURus, cULus							
	Output voltage	24 V	24 V	24 V	24 V	24 V	24 V
	Output current	11 A	18 A	22 A	26 A	32 A	42 A
	Order No.	8628620000	8628630000	8628650000	8628660000	8628670000	8628680000
Page	D.7	D.7	D.8	D.8	D.9	D.9	

Electrical cabinet socket outlet

Earthed socket outlet for the TS35 mounting rail VDE		
	Output voltage	250 V AC
Output current	16 A	
Order No.	8734580000	
Page	E.2	

Switch-mode power supplies

Switch-mode power supplies	Overview	A.2
	connectPower PROeco	A.4
	connectPower PRO-M	A.12
	connectPower PRO-H	A.26
	connectPower PRO-E	A.40
	connectPower INSTAPOWER	A.56
	connectPower WAVEPOWER	A.64
	connectPower DC/DC converter	A.66

Switch-mode power supplies

The switch-mode power supplies feature a high degree of efficiency, compact dimensions and minimal heat generation.

They are an excellent, reliable solution for providing power in all automation applications – safely providing 24 V DC voltage.

The different product series are optimised for the automation industry: they feature Ex approvals for the processing industry, a flat shape perfect for distribution tasks within buildings, or provide decentralised control voltages.

All-purpose usage: with a wide range of AC/DC inputs, single-, double- or three-phase versions, and a wide temperature range. Additional performance increases are possible using simple parallel circuitry. Weidmüller

switch-mode power supplies can be depended upon for all applications because of their high efficiency and their resistance to both short circuits and overloads.

Weidmüller offers a system of one- and three-phase switch-mode power supplies especially for the PRO-M family. These can be expanded with additional modules to create whole system solutions. The appropriate system can be assembled for any type of application: with redundancy circuits containing decoupled outputs, monitoring of the output voltage or triggering of circuit breakers.



AC/DC**International use**

A wide-range input (both DC as well as AC voltages can be used; no switching required) and extensive approvals (UL/CSA and GL (EMC 1 – bridge)).

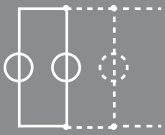
**Parallel connection**

Module power can be increased by connecting up to five power supplies in parallel without diode module.

**Narrow**

Space-saving configuration in the switching cabinet through very narrow housing construction and side-by-side connectability.

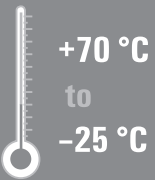
**Robust**

Wide temperature range from -25 °C ... +70 °C.

**Wide choice**

The right power supply for every application: 1-phase 3 A, 5 A, 7.5 A, 10 A, 20 A, 40 A and 3-phase 5 A, 10 A, 20 A, 40 A.

connectPower**connectPower PROeco****connectPower PRO-M****connectPower PRO-H****connectPower PRO-E****connectPower INSTAPOWER****connectPower WAVEPOWER****connectPower DC/DC converters**

PROeco power supplies with basic functionality and a high level of reliability

- Single- and three-phase switched-mode power supply units
- Slim design
- Large temperature range from -25 °C to 70 °C
- The output voltage can be precisely adjusted via the potentiometer on the front
- Remote monitoring via integrated status relay
- Three-coloured LED indicators for simple error detection
- Advanced visual warning at 90 % rated output current
- International approvals



Derating curves

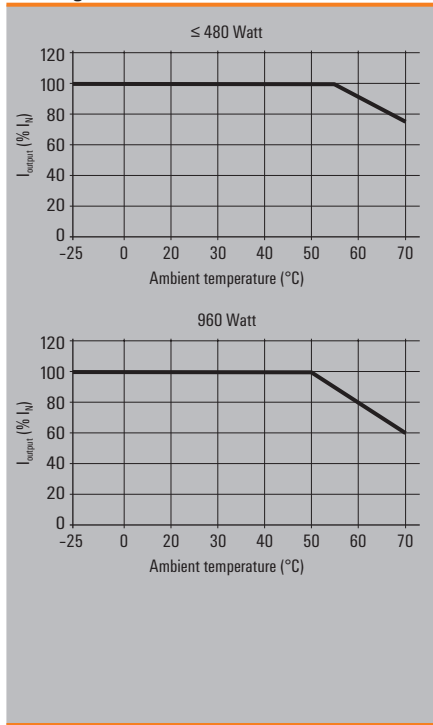

Technical data

General technical data	
Ambient temp. operating / storage temperature	-25 °C...+70 °C / -40 °C...+85 °C
Max. perm. air humidity (operation)	5 %...95 % RH
Degree of protection	IP 20
Class of protection	I, with PE connection
Pollution degree	2
Insulation voltage input/output	3 kV E/A / 2 kV E/earth / 0.5 kV A/earth
MTBF	> 500.000 h acc. to IEC 1709 (SN29500)
Parallel connection option	yes, max. 5 without diode module
Housing version	metal, corrosion resistant
Mounting position, installation notice	horizontal on mounting rail TS 35, 50 mm spacing top and bottom for free air circulation
Short-circuit protection	Yes, automatic restart
Overload protection	Yes, IU characteristic curve
Overtemperature protection	Yes, automatic restart
EMC / shock / vibration	
Noise emission acc. to EN55022	Class B
Noise immunity tests acc. to	EN61000-4-2 (ESD), EN61000-4-3 and EN61000-4-8 (Fields), EN61000-4-4 (Burst), EN61000-4-5 (Surge), EN61000-4-6 (conducted), EN61000-4-11 (Dips)
Limiting of mains voltage harmonic currents	Acc. to EN61000-3-2
Resistance against vibration and shock	1 g acc. to EN50178, shock: 15 g in all directions
Electrical safety (applied standards)	
Electrical equipment of machines	Acc. to EN60204
Safety transformers for switched-mode power units	Acc. to EN61558-2-17
Machinery with electronic equipment	Acc. to EN50178 / VDE0160
Safety extra-low voltage	SELV acc. to EN60950-1, PELV acc. to EN60204-1
Protective separation / protection against electrical shock	VDE0100-410 / acc. to DIN57100-410
Protection against dangerous shock currents	Acc. to VDE0106-101

PROeco

PRO ECO 72W 24V 3A

PRO ECO 120W 24V 5A

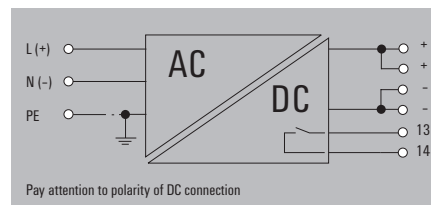
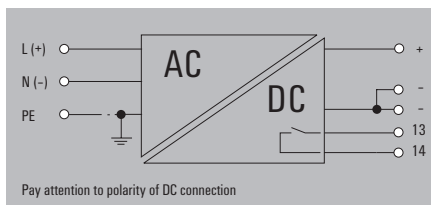
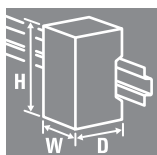

Technical data

Input	
Rated input voltage	100 ... 240 V AC
AC input voltage range	85 ... 264 V AC (Derating @ 100 V AC)
AC frequency range	47 ... 63 Hz
DC input voltage range	80 ... 370 DC (Derating @ 120 V DC)
AC current consumption	0.55 A @ 230 V AC / 1.04 A @ 110 V AC
DC current consumption	0.22 A @ 370 V DC / 0.68 A @ 120 V DC
Input fuse (internal) / inrush current	Yes / max. 40
Recommended back-up fuse	2 A / DI, Safety fuse 6 A, Char. B, Circuit breaker 2...4 A, Char. C, Circuit breaker

Output	
Rated output voltage	24 V DC ± 1 %
Output voltage	22...28 V DC (adjustable via potentiometer on front)
Ramp-up time / residual ripple, switching peaks	< 100 ms / < 50 mVSS @ 24 V DC, I _h
Rated output current @ U _{rated}	3 A up to 55 °C
Continuous output current @ 24 V DC	3 A @ 55 °C, 2.25 A @ 70 °C
Power boost @ 24 V DC, 60 °C	3.6 A for 1 min, ED = 5 %
Capacitive load	Unrestricted
Protection against reverse voltages from the load	30...35 V DC
Protection against internal surge voltage	35 V DC

Signalling	
DC OK	LED Green (U _{output} > 21.6 V DC)
Alarm	LED Yellow (I _{output} > 90 % I _h)
Error	LED Red (Overload, overtemperature, short-circuit, U _{output} < 20.4 V DC)
Voltage monitoring / no-voltage contact / contact load	Yes / NO contact / max. 30 V AC/DC 1 A
On/Off relay	Output voltage > 21.6 V DC / < 20.4 V DC

General data	
Efficiency	> 87 % @ 230 V AC & 3 A
Power loss @ idling / nominal load	4 W / 9.5 W
Earth discharge current	< 1 mA
Power factor (approx.)	> 0.42 @ 230 V AC / > 0.45 @ 115 V AC
Mains buffering @ I _{rated}	> 100 ms @ 230 V AC / > 20 ms @ 115 V AC
Parallel connection option	yes, max. 5
Height x width x depth / weight	125 / 34 / 100 mm / 0.5 kg

Approvals	
Approvals	CE, TÜV (EN/IEC 60950-1), cULus (Pending)

Connection data	
Conductor connection system	Screw connection
Number of terminals	3 for L/N/PE
Wire cross-section, rigid min/max	0.5/6 mm ²
Wire cross-section, flexible min/max	0.5/2.5 mm ²
Wire cross-section, AWG/kcmil	26/12 min/max
Min./max. tightening torque range	0.5/0.6 Nm
Stripping length	6 mm

Note	

Ordering data

Type	Qty.	Order No.
PRO ECO 72W 24V 3A	1	1469470000
The internal varistor found in a switch-mode power unit does not replace the necessary surge protection in a system.		

Rated input voltage	100 ... 240 V AC
AC input voltage range	85 ... 264 V AC (Derating @ 100 V AC)
AC frequency range	47 ... 63 Hz
DC input voltage range	80 ... 370 DC (Derating @ 120 V DC)
AC current consumption	0.55 A @ 230 V AC / 1.04 A @ 110 V AC
DC current consumption	0.22 A @ 370 V DC / 0.68 A @ 120 V DC
Input fuse (internal) / inrush current	Yes / max. 40
Recommended back-up fuse	2 A / DI, Safety fuse 6 A, Char. B, Circuit breaker 2...4 A, Char. C, Circuit breaker

Rated output voltage	24 V DC ± 1 %
Output voltage	22...28 V DC (adjustable via potentiometer on front)
Ramp-up time / residual ripple, switching peaks	< 100 ms / < 50 mVSS @ 24 V DC, I _h
Rated output current @ U _{rated}	3 A up to 55 °C
Continuous output current @ 24 V DC	3 A @ 55 °C, 2.25 A @ 70 °C
Power boost @ 24 V DC, 60 °C	3.6 A for 1 min, ED = 5 %
Capacitive load	Unrestricted
Protection against reverse voltages from the load	30...35 V DC
Protection against internal surge voltage	35 V DC

DC OK	LED Green (U _{output} > 21.6 V DC)
Alarm	LED Yellow (I _{output} > 90 % I _h)
Error	LED Red (Overload, overtemperature, short-circuit, U _{output} < 20.4 V DC)
Voltage monitoring / no-voltage contact / contact load	Yes / NO contact / max. 30 V AC/DC 1 A
On/Off relay	Output voltage > 21.6 V DC / < 20.4 V DC

Efficiency	> 87 % @ 230 V AC & 3 A
Power loss @ idling / nominal load	4 W / 9.5 W
Earth discharge current	< 1 mA
Power factor (approx.)	> 0.42 @ 230 V AC / > 0.45 @ 115 V AC
Mains buffering @ I _{rated}	> 100 ms @ 230 V AC / > 20 ms @ 115 V AC
Parallel connection option	yes, max. 5
Height x width x depth / weight	125 / 34 / 100 mm / 0.5 kg

Approvals	CE, TÜV (EN/IEC 60950-1), cULus (Pending)
-----------	---

Connection data	
Conductor connection system	Screw connection
Number of terminals	3 for L/N/PE
Wire cross-section, rigid min/max	0.5/6 mm ²
Wire cross-section, flexible min/max	0.5/2.5 mm ²
Wire cross-section, AWG/kcmil	26/12 min/max
Min./max. tightening torque range	0.5/0.6 Nm
Stripping length	6 mm

Note	

Rated input voltage	100 ... 240 V AC
AC input voltage range	85 ... 264 V AC (Derating @ 100 V AC)
AC frequency range	47 ... 63 Hz
DC input voltage range	80 ... 370 DC (Derating @ 120 V DC)
AC current consumption	1.26 A @ 230 V AC / 2.24 A @ 110 V AC
DC current consumption	0.39 A @ 370 V DC / 1.16 A @ 120 V DC
Input fuse (internal) / inrush current	Yes / max. 40
Recommended back-up fuse	4 A / DI, Safety fuse 6 A, Char. B, Circuit breaker 3...5 A, Char. C, Circuit breaker

Rated output voltage	24 V DC ± 1 %
Output voltage	22...28 V DC (adjustable via potentiometer on front)
Ramp-up time / residual ripple, switching peaks	< 100 ms / < 50 mVSS @ 24 V DC, I _h
Rated output current @ U _{rated}	5 A up to 55 °C
Continuous output current @ 24 V DC	5 A @ 55 °C, 3.75 A @ 70 °C
Power boost @ 24 V DC, 60 °C	6 A for 1 min, ED = 5 %
Capacitive load	Unrestricted
Protection against reverse voltages from the load	30...35 V DC
Protection against internal surge voltage	35 V DC

DC OK	LED Green (U _{output} > 21.6 V DC)
Alarm	LED Yellow (I _{output} > 90 % I _h)
Error	LED Red (Overload, overtemperature, short-circuit, U _{output} < 20.4 V DC)
Voltage monitoring / no-voltage contact / contact load	Yes / NO contact / max. 30 V AC/DC 1 A
On/Off relay	Output voltage > 21.6 V DC / < 20.4 V DC

Efficiency	> 87 % @ 230 V AC & 5 A
Power loss @ idling / nominal load	4 W / 15 W
Earth discharge current	< 1 mA
Power factor (approx.)	> 0.47 @ 230 V AC / > 0.56 @ 115 V AC
Mains buffering @ I _{rated}	> 80 ms @ 230 V AC / > 20 ms @ 115 V AC
Parallel connection option	yes, max. 5
Height x width x depth / weight	125 / 40 / 100 mm / 0.6 kg

Approvals	CE, TÜV (EN/IEC 60950-1), cULus (Pending)
-----------	---

Connection data	
Conductor connection system	Screw connection
Number of terminals	3 for L/N/PE
Wire cross-section, rigid min/max	0.5/6 mm ²
Wire cross-section, flexible min/max	0.5/2.5 mm ²
Wire cross-section, AWG/kcmil	26/12 min/max
Min./max. tightening torque range	0.5/0.6 Nm
Stripping length	6 mm

Note	

Type	Qty.	Order No.
PRO ECO 120W 24V 5A	1	1469480000
The internal varistor found in a switch-mode power unit does not replace the necessary surge protection in a system.		

PROeco

PRO ECO 240W 24V 10A

PRO ECO 480W 24V 20A

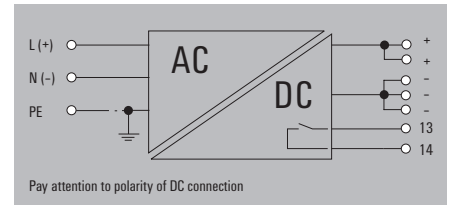
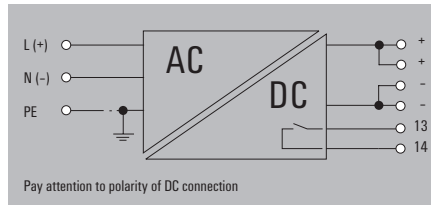
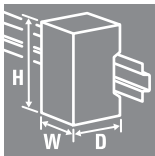

Technical data

Input	
Rated input voltage	100 ... 240 V AC
AC input voltage range	85 ... 264 V AC (Derating @ 100 V AC)
AC frequency range	47 ... 63 Hz
DC input voltage range	80 ... 370 DC (Derating @ 120 V DC)
AC current consumption	1.23 A @ 230 V AC / 2.47 A @ 110 V AC
DC current consumption	1.18 A @ 370 V DC / 2.4 A @ 120 V DC
Input fuse (internal) / inrush current	Yes / max. 15 A
Recommended back-up fuse	4 A / DI, Safety fuse 10 A, Char. B, Circuit breaker 3...4 A, Char. C, Circuit breaker
Output	
Rated output voltage	24 V DC ± 1 %
Output voltage	22...28 V DC (adjustable via potentiometer on front)
Ramp-up time / residual ripple, switching peaks	< 100 ms / < 50 mVSS @ 24 V DC, I _h
Rated output current @ U _{rated}	10 A up to 55 °C
Continuous output current @ 24 V DC	10 A @ 55 °C, 7.5 A @ 70 °C
Power boost @ 24 V DC, 60 °C	12 A for 1 min, ED = 5 %
Capacitive load	Unrestricted
Protection against reverse voltages from the load	30...35 V DC
Protection against internal surge voltage	35 V DC
Signalling	
DC OK	LED Green (U _{output} > 21.6 V DC)
Alarm	LED Yellow (I _{output} > 90 % I _h)
Error	LED Red (Overload, overtemperature, short-circuit, U _{output} < 20.4 V DC)
Voltage monitoring / no-voltage contact / contact load	Yes / NO contact / max. 30 V AC/DC 1 A
On/Off relay	Output voltage > 21.6 V DC / < 20.4 V DC
General data	
Efficiency	> 90 % @ 230 V AC & 10 A
Power loss @ idling / nominal load	3 W / 24 W
Earth discharge current	< 1 mA
Power factor (approx.)	> 0.93 @ 230 V AC / > 0.99 @ 115 V AC
Mains buffering @ I _{rated}	> 20 ms @ 230 V AC / > 20 ms @ 115 V AC
Parallel connection option	yes, max. 5
Height x width x depth / weight	125 / 60 / 100 mm / 1 kg
Approvals	
Approvals	CE, TÜV (EN/IEC 60950-1), cULus (Pending)
Connection data	
Conductor connection system	Input Output
Number of terminals	Screw connection Screw connection
Wire cross-section, rigid min/max	3 for L/N/PE 6 (13,14,+,+,-,-)
Wire cross-section, flexible min/max	0.5/6 0.5/6
Wire cross-section, AWG/kcmil	0.5/2.5 0.5/2.5
Min./max. tightening torque range	26/12 26/12
Stripping length	0.5/0.6 0.5/0.6
Note	6 6

Ordering data

Type	Qty.	Order No.
PRO ECO 240W 24V 10A	1	1469490000
Note		
The internal varistor found in a switch-mode power unit does not replace the necessary surge protection in a system.		

Input	
Rated input voltage	100 ... 240 V AC
AC input voltage range	85 ... 264 V AC (Derating @ 100 V AC)
AC frequency range	47 ... 63 Hz
DC input voltage range	80 ... 370 DC (Derating @ 120 V DC)
AC current consumption	2.37 A @ 230 V AC / 5.2 A @ 110 V AC
DC current consumption	1.55 A @ 370 V DC / 4.65 A @ 120 V DC
Input fuse (internal) / inrush current	Yes / max. 3 A
Recommended back-up fuse	6 A / DI, Safety fuse 16 A, Char. B, Circuit breaker 6...8 A, Char. C, Circuit breaker
Output	
Rated output voltage	24 V DC ± 1 %
Output voltage	22...28 V DC (adjustable via potentiometer on front)
Ramp-up time / residual ripple, switching peaks	< 100 ms / < 50 mVSS @ 24 V DC, I _h
Rated output current @ U _{rated}	20 A up to 55 °C
Continuous output current @ 24 V DC	20 A @ 55 °C, 15 A @ 70 °C
Power boost @ 24 V DC, 60 °C	24 A for 1 min, ED = 5 %
Capacitive load	Unrestricted
Protection against reverse voltages from the load	30...35 V DC
Protection against internal surge voltage	35 V DC
Signalling	
DC OK	LED Green (U _{output} > 21.6 V DC)
Alarm	LED Yellow (I _{output} > 90 % I _h)
Error	LED Red (Overload, overtemperature, short-circuit, U _{output} < 20.4 V DC)
Voltage monitoring / no-voltage contact / contact load	Yes / NO contact / max. 30 V AC/DC 1 A
On/Off relay	Output voltage > 21.6 V DC / < 20.4 V DC
General data	
Efficiency	> 91 % @ 230 V AC & 20 A
Power loss @ idling / nominal load	5 W / 43 W
Earth discharge current	< 1 mA
Power factor (approx.)	> 0.97 @ 230 V AC / > 0.99 @ 115 V AC
Mains buffering @ I _{rated}	> 20 ms @ 230 V AC / > 20 ms @ 115 V AC
Parallel connection option	yes, max. 3
Height x width x depth / weight	125 / 100 / 120 mm / 1.6 kg
Approvals	
Approvals	CE, TÜV (EN/IEC 60950-1), cULus (Pending)
Connection data	
Conductor connection system	Input Output
Number of terminals	Screw connection Screw connection
Wire cross-section, rigid min/max	3 for L/N/PE 7 (13,14,+,+,-,-,-)
Wire cross-section, flexible min/max	0.5/6 0.18/6
Wire cross-section, AWG/kcmil	0.5/2.5 0.5/2.5
Min./max. tightening torque range	26/12 26/10
Stripping length	0.5/0.6 0.5/0.6
Note	6 7

Type	Qty.	Order No.
PRO ECO 480W 24V 20A	1	1469510000
Note		
The internal varistor found in a switch-mode power unit does not replace the necessary surge protection in a system.		

PROeco

PRO ECO 960W 24V 40A

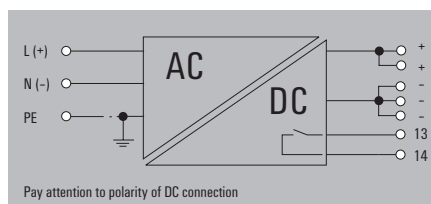
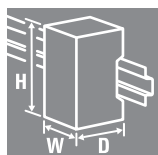

Technical data

Input	
Rated input voltage	100 ... 240 V AC
AC input voltage range	85 ... 264 V AC (Derating @ 100 V AC)
AC frequency range	47 ... 63 Hz
DC input voltage range	80 ... 370 DC (Derating @ 120 V DC)
AC current consumption	4.6 A @ 230 V AC / 9.9 A @ 110 V AC
DC current consumption	2.9 A @ 370 V DC / 9 A @ 120 V DC
Input fuse (internal) / inrush current	Yes / max. 3 A
Recommended back-up fuse	16 A / DI, Safety fuse 20 A, Char. B, Circuit breaker 16 A, Char. C, Circuit breaker
Output	
Rated output voltage	24 V DC \pm 1 %
Output voltage	22...28 V DC (adjustable via potentiometer on front)
Ramp-up time / residual ripple, switching peaks	< 100 ms / < 50 mVSS @ 24 V DC, I _h
Rated output current @ U _{rated}	40 A up to 50 °C
Continuous output current @ 24 V DC	40 A @ 50 °C, 24 A @ 70 °C
Power boost @ 24 V DC, 60 °C	48 A for 1 min, ED = 5 %
Capacitive load	Unrestricted
Protection against reverse voltages from the load	30...35 V DC
Protection against internal surge voltage	35 V DC
Signalling	
DC OK	LED Green (U _{output} > 21.6 V DC)
Alarm	LED Yellow (I _{output} > 90 % I _R)
Error	LED Red (Overload, overtemperature, short-circuit, U _{output} < 20.4 V DC)
Voltage monitoring / no-voltage contact / contact load	Yes / NO contact / max. 30 V AC/DC 1 A
On/Off relay	Output voltage > 21.6 V DC / < 20.4 V DC
General data	
Efficiency	> 93 % @ 230 V AC & 40 A
Power loss @ idling / nominal load	6 W / 76 W
Earth discharge current	< 1 mA
Power factor (approx.)	> 0.97 @ 230 V AC / > 0.99 @ 115 V AC
Mains buffering @ U _{rated}	> 20 ms @ 230 V AC / > 20 ms @ 115 V AC
Parallel connection option	yes, max. 3
Height x width x depth / weight	125 / 160 / 120 mm / 2.9 kg
Approvals	
Approvals	CE, TÜV (EN/IEC 60950-1), cULus (Pending)
Connection data	
Conductor connection system	Screw connection
Number of terminals	3 for L/N/PE
Wire cross-section, rigid min/max	0.18/6
Wire cross-section, flexible min/max	0.5/2.5
Wire cross-section, AWG/kcmil	26/10
Min./max. tightening torque range	0.5/0.6
Stripping length	7
Note	

Ordering data

Type	Qty.	Order No.
PRO ECO 960W 24V 40A	1	1469520000
The internal varistor found in a switch-mode power unit does not replace the necessary surge protection in a system.		
Note		

PROeco

PRO ECO3 120W 24V 5A

PRO ECO3 240W 24V 10A

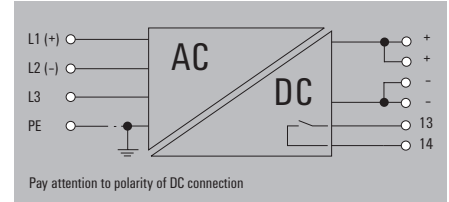
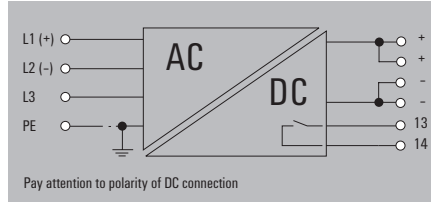
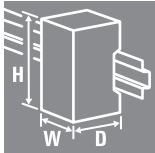

Technical data

Input	
Rated input voltage	3 x 400...3 x 500 V AC (Wide-range input)
AC input voltage range	3 x 340...3 x 575 V AC / 2 x 360...2 x 575 V AC
AC frequency range	47...63 Hz
DC input voltage range	450...800 V DC (max. 500 V DC in accordance with UL 508)
AC current consumption	0.3 A @ 3 x 500 V AC / 0.4 A @ 3 x 400 V AC
DC current consumption	0.2 A @ 800 V DC / 0.4 A @ 450 V DC
Input fuse (internal) / inrush current	Yes / max. 40 A
Recommended back-up fuse	2 A / DI, Safety fuse 2...3 A, Char. C, Circuit breaker
Output	
Rated output voltage	24 V DC ± 1 %
Output voltage	22...28 V DC (adjustable via potentiometer on front)
Ramp-up time / residual ripple, switching peaks	< 100 ms / < 50 mVSS @ 24 V DC, I _h
Rated output current @ U _{rated}	5 A up to 55 °C
Continuous output current @ 24 V DC	5 A @ 55 °C, 3.75 A @ 70 °C
Power boost @ 24 V DC, 60 °C	6 A for 1 min, ED = 5 %
Capacitive load	Unrestricted
Protection against reverse voltages from the load	30...35 V DC
Protection against internal surge voltage	35 V DC
Signalling	
DC OK	LED Green (U _{output} > 21.6 V DC)
Alarm	LED Yellow (I _{output} > 90 % I _h)
Error	LED Red (Overload, overtemperature, short-circuit, U _{output} < 20.4 V DC)
Voltage monitoring / no-voltage contact / contact load	Yes / NO contact / max. 30 V AC/DC 1 A
On/Off relay	Output voltage > 21.6 V DC / < 20.4 V DC
General data	
Efficiency	87 % @ 3 x 500 V AC / 88 % @ 3 x 400 V AC
Power loss @ idling / nominal load	6 W / 13 W
Earth discharge current	< 1 mA
Power factor (approx.)	> 0.4 @ 3 x 500 V AC / > 0.45 @ 3 x 400 V AC
Mains buffering @ I _{rated}	> 40 ms @ 3 x 500 V AC / > 20 ms @ 3 x 400 V AC
Parallel connection option	yes, max. 5
Height x width x depth / weight	125 / 40 / 100 mm / 0.6 kg
Approvals	
Approvals	CE, TÜV (EN/IEC 60950-1), cULus (Pending)
Connection data	
Conductor connection system	Screw connection
Number of terminals	4 for L1/L2/L3/PE
Wire cross-section, rigid min/max	0.18/6
Wire cross-section, flexible min/max	0.5/2.5
Wire cross-section, AWG/kcmil	26/10
Min./max. tightening torque range	0.5/0.6
Stripping length	8
Note	

Input	
Rated input voltage	3 x 400...3 x 500 V AC (Wide-range input)
AC input voltage range	3 x 340...3 x 575 V AC / 2 x 360...2 x 575 V AC
AC frequency range	47...63 Hz
DC input voltage range	450...800 V DC (max. 500 V DC in accordance with UL 508)
AC current consumption	0.3 A @ 3 x 500 V AC / 0.4 A @ 3 x 400 V AC
DC current consumption	0.2 A @ 800 V DC / 0.4 A @ 450 V DC
Input fuse (internal) / inrush current	Yes / max. 40 A
Recommended back-up fuse	2 A / DI, Safety fuse 2...3 A, Char. C, Circuit breaker
Output	
Rated output voltage	24 V DC ± 1 %
Output voltage	22...28 V DC (adjustable via potentiometer on front)
Ramp-up time / residual ripple, switching peaks	< 100 ms / < 50 mVSS @ 24 V DC, I _h
Rated output current @ U _{rated}	10 A up to 55 °C
Continuous output current @ 24 V DC	10 A @ 55 °C, 7.5 A @ 70 °C
Power boost @ 24 V DC, 60 °C	12 A for 1 min, ED = 5 %
Capacitive load	Unrestricted
Protection against reverse voltages from the load	30...35 V DC
Protection against internal surge voltage	35 V DC
Signalling	
DC OK	LED Green (U _{output} > 21.6 V DC)
Alarm	LED Yellow (I _{output} > 90 % I _h)
Error	LED Red (Overload, overtemperature, short-circuit, U _{output} < 20.4 V DC)
Voltage monitoring / no-voltage contact / contact load	Yes / NO contact / max. 30 V AC/DC 1 A
On/Off relay	Output voltage > 21.6 V DC / < 20.4 V DC
General data	
Efficiency	88 % @ 3 x 500 V AC / 89 % @ 3 x 400 V AC
Power loss @ idling / nominal load	8 W / 26 W
Earth discharge current	< 0.5 mA
Power factor (approx.)	> 0.45 @ 3 x 500 V AC / > 0.5 @ 3 x 400 V AC
Mains buffering @ I _{rated}	> 40 ms @ 3 x 500 V AC / > 20 ms @ 3 x 400 V AC
Parallel connection option	yes, max. 5
Height x width x depth / weight	125 / 60 / 100 mm / 1 kg
Approvals	
Approvals	CE, TÜV (EN/IEC 60950-1), cULus (Pending)
Connection data	
Conductor connection system	Screw connection
Number of terminals	4 for L1/L2/L3/PE
Wire cross-section, rigid min/max	0.18/6
Wire cross-section, flexible min/max	0.5/2.5
Wire cross-section, AWG/kcmil	26/10
Min./max. tightening torque range	0.5/0.6
Stripping length	7
Note	

Input	
Rated input voltage	3 x 400...3 x 500 V AC (Wide-range input)
AC input voltage range	3 x 340...3 x 575 V AC / 2 x 360...2 x 575 V AC
AC frequency range	47...63 Hz
DC input voltage range	450...800 V DC (max. 500 V DC in accordance with UL 508)
AC current consumption	0.6 A @ 3 x 500 V AC / 0.8 A @ 3 x 400 V AC
DC current consumption	0.4 A @ 800 V DC / 0.7 A @ 450 V DC
Input fuse (internal) / inrush current	Yes / max. 50 A
Recommended back-up fuse	2 A / DI, Safety fuse 2...3 A, Char. C, Circuit breaker
Output	
Rated output voltage	24 V DC ± 1 %
Output voltage	22...28 V DC (adjustable via potentiometer on front)
Ramp-up time / residual ripple, switching peaks	< 100 ms / < 50 mVSS @ 24 V DC, I _h
Rated output current @ U _{rated}	10 A up to 55 °C
Continuous output current @ 24 V DC	10 A @ 55 °C, 7.5 A @ 70 °C
Power boost @ 24 V DC, 60 °C	12 A for 1 min, ED = 5 %
Capacitive load	Unrestricted
Protection against reverse voltages from the load	30...35 V DC
Protection against internal surge voltage	35 V DC
Signalling	
DC OK	LED Green (U _{output} > 21.6 V DC)
Alarm	LED Yellow (I _{output} > 90 % I _h)
Error	LED Red (Overload, overtemperature, short-circuit, U _{output} < 20.4 V DC)
Voltage monitoring / no-voltage contact / contact load	Yes / NO contact / max. 30 V AC/DC 1 A
On/Off relay	Output voltage > 21.6 V DC / < 20.4 V DC
General data	
Efficiency	88 % @ 3 x 500 V AC / 89 % @ 3 x 400 V AC
Power loss @ idling / nominal load	8 W / 26 W
Earth discharge current	< 0.5 mA
Power factor (approx.)	> 0.45 @ 3 x 500 V AC / > 0.5 @ 3 x 400 V AC
Mains buffering @ I _{rated}	> 40 ms @ 3 x 500 V AC / > 20 ms @ 3 x 400 V AC
Parallel connection option	yes, max. 5
Height x width x depth / weight	125 / 60 / 100 mm / 1 kg
Approvals	
Approvals	CE, TÜV (EN/IEC 60950-1), cULus (Pending)
Connection data	
Conductor connection system	Screw connection
Number of terminals	4 for L1/L2/L3/PE
Wire cross-section, rigid min/max	0.18/6
Wire cross-section, flexible min/max	0.5/2.5
Wire cross-section, AWG/kcmil	26/10
Min./max. tightening torque range	0.5/0.6
Stripping length	7
Note	

Ordering data

Type	Qty.	Order No.
PRO ECO3 120W 24V 5A	1	1469530000
The internal varistor found in a switch-mode power unit does not replace the necessary surge protection in a system.		
Note		

Type	Qty.	Order No.
PRO ECO3 240W 24V 10A	1	1469540000
The internal varistor found in a switch-mode power unit does not replace the necessary surge protection in a system.		
Note		

Type	Qty.	Order No.
PRO ECO3 240W 24V 10A	1	1469540000
The internal varistor found in a switch-mode power unit does not replace the necessary surge protection in a system.		
Note		

PROeco

PRO ECO3 480W 24V 20A

PRO ECO3 960W 24V 40A

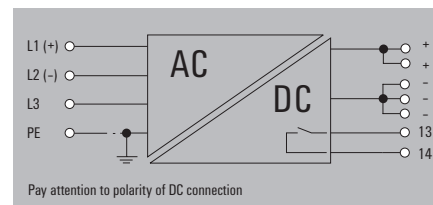
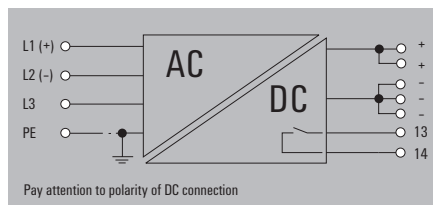
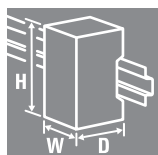

Technical data

Input	
Rated input voltage	
AC input voltage range	
AC frequency range	
DC input voltage range	
AC current consumption	
DC current consumption	
Input fuse (internal) / inrush current	
Recommended back-up fuse	

3 x 400...3 x 500 V AC (Wide-range input)
3 x 340...3 x 575 V AC / 2 x 360...2 x 575 V AC
47...63 Hz
450...800 V DC (max. 500 V DC in accordance with UL 508)
1.2 A @ 3 x 500 V AC / 1.5 A @ 3 x 400 V AC
0.7 A @ 800 V DC / 1.2 A @ 450 V DC
Yes / max. 50 A
4 A / DI, Safety fuse
3...5 A, Char. C, Circuit breaker

3 x 400...3 x 500 V AC (Wide-range input)
3 x 340...3 x 575 V AC / 2 x 360...2 x 575 V AC
47...63 Hz
450...800 V DC (max. 500 V DC in accordance with UL 508)
2.15 A @ 3 x 500 V AC / 2.68 A @ 3 x 400 V AC
1.37 A @ 800 V DC / 2.37 A @ 450 V DC
Yes / max. 40 A
6 A / DI, Safety fuse
10 A, Char. B, Circuit breaker
6...8 A, Char. C, Circuit breaker

Output	
Rated output voltage	
Output voltage	
Ramp-up time / residual ripple, switching peaks	
Rated output current @ U _{rated}	
Continuous output current @ 24 V DC	
Power boost @ 24 V DC, 60 °C	
Capacitive load	
Protection against reverse voltages from the load	
Protection against internal surge voltage	

24 V DC ± 1 %
22...28 V DC (adjustable via potentiometer on front)
< 100 ms / < 50 mVSS @ 24 V DC, I _h
20 A up to 55 °C
20 A @ 55 °C, 15 A @ 70 °C
24 A for 1 min, ED = 5 %
Unrestricted
30...35 V DC
35 V DC

24 V DC ± 1 %
22...28 V DC (adjustable via potentiometer on front)
< 100 ms / < 50 mVSS @ 24 V DC, I _h
40 A up to 50 °C
40 A @ 50 °C, 24 A @ 70 °C
48 A for 1 min, ED = 5 %
Unrestricted
30...35 V DC
35 V DC

Signalling	
DC OK	
Alarm	
Error	
Voltage monitoring / no-voltage contact / contact load	
On/Off relay	

LED Green (U _{output} > 21.6 V DC)
LED Yellow (I _{output} > 90 % I _h)
LED Red (Overload, overtemperature, short-circuit, U _{output} < 20.4 V DC)
Yes / NO contact / max. 30 V AC/DC 1 A
Output voltage > 21.6 V DC / < 20.4 V DC

LED Green (U _{output} > 21.6 V DC)
LED Yellow (I _{output} > 90 % I _h)
LED Red (Overload, overtemperature, short-circuit, U _{output} < 20.4 V DC)
Yes / NO contact / max. 30 V AC/DC 1 A
Output voltage > 21.6 V DC / < 20.4 V DC

General data	
Efficiency	
Power loss @ idling / nominal load	
Earth discharge current	
Power factor (approx.)	
Mains buffering @ U _{rated}	
Parallel connection option	
Height x width x depth / weight	

89 % @ 3 x 500 V AC / 90 % @ 3 x 400 V AC
8 W / 48 W
< 0.5 mA
> 0.41 @ 3 x 500 V AC / > 0.43 @ 3 x 400 V AC
> 30 ms @ 3 x 500 V AC / > 20 ms @ 3 x 400 V AC
yes, max. 3
125 / 100 / 120 mm / 1.3 kg

90 % @ 3 x 500 V AC / 91 % @ 3 x 400 V AC
5 W / 95 W
< 1 mA
> 0.56 @ 3 x 500 V AC / > 0.56 @ 3 x 400 V AC
> 25 ms @ 3 x 500 V AC / > 20 ms @ 3 x 400 V AC
yes, max. 3
125 / 160 / 120 mm / 2.5 kg

Approvals	
Approvals	

CE, TÜV (EN/IEC 60950-1), cULus (Pending)

CE, TÜV (EN/IEC 60950-1), cULus (Pending)

Connection data	
Conductor connection system	
Number of terminals	
Wire cross-section, rigid min/max	mm ²
Wire cross-section, flexible min/max	mm ²
Wire cross-section, AWG/kcmil	min/max
Min./max. tightening torque range	Nm
Stripping length	mm

Input	Output
Screw connection	Screw connection
4 for L1/L2/L3/PE	7 (13,14,+,+,-,-)
0.18/6	0.18/6
0.5/2.5	0.5/2.5
26/10	26/10
0.5/0.6	0.5/0.6
7	7

Input	Output
Screw connection	Screw connection
4 for L1/L2/L3/PE	7 (13,14,+,+,-,-)
0.18/6	0.5/16
0.5/2.5	2.5/10
26/10	22/8
0.5/0.6	1.2/1.5
7	12

Note	

Ordering data

Type	Qty.	Order No.
PRO ECO3 480W 24V 20A	1	1469550000
The internal varistor found in a switch-mode power unit does not replace the necessary surge protection in a system.		
Note		

Type	Qty.	Order No.
PRO ECO3 960W 24V 40A	1	1469560000
The internal varistor found in a switch-mode power unit does not replace the necessary surge protection in a system.		

Type	Qty.	Order No.
PRO ECO3 960W 24V 40A	1	1469560000
The internal varistor found in a switch-mode power unit does not replace the necessary surge protection in a system.		

connectPower PROeco

connectPower PROeco diode module

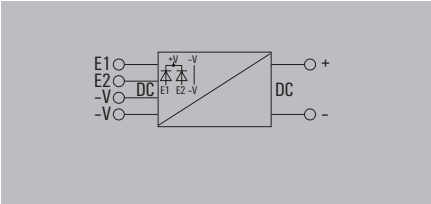
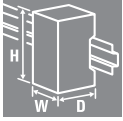

Technical data

Input	
Input voltage	
Input current	
Output	
Output voltage	
Output current	
General data	
Ambient temperature (operational)	
Storage temperature	
Degree of efficiency at max. load	
Mounting position, installation notice	
Installation advice	
Weight	
Approvals	

CP DM 10

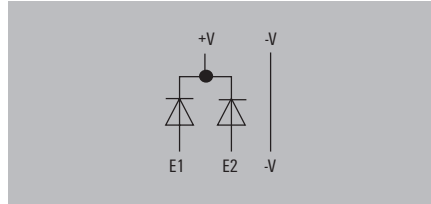

Input voltage	40 V DC max.
Input current	2 x 0...10 A max.
Output voltage	U_m - 0.5 V typical
Output current	0...20 A max. or 10 A max. for redundancy operation
Ambient temperature (operational)	-10 °C...+55 °C
Storage temperature	-20 °C...+85 °C
Degree of efficiency at max. load	95.5%
Mounting position, installation notice	horizontally, on terminal rail TS 35
Installation advice	Space: side \geq 2 cm; above/below \geq 10 cm
Weight	0.4 kg
Approvals	CE; cULus; cURus

CP DM 20

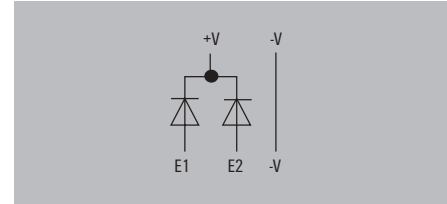

Input voltage	40 V DC max.
Input current	2 x 0...20 A max.
Output voltage	U_m - 0.5 V typical
Output current	0...40 A max. or 20 A max. for redundant operations
Ambient temperature (operational)	-10 °C...+55 °C
Storage temperature	-20 °C...+85 °C
Degree of efficiency at max. load	97.5%
Mounting position, installation notice	horizontally, on terminal rail TS 35
Installation advice	Space: side \geq 2 cm; above/below \geq 10 cm
Weight	0.4 kg
Approvals	CE; cULus; cURus

Dimensions	
Clamping range (nominal / min. / max.)	mm ²
Depth x width x height	mm
Note	

Input	Output
4 / 0.13 / 6	4 / 0.13 / 6
110 / 55.5 / 125	110 / 55.5 / 125

Input	Output
4 / 0.13 / 6	10 / 0.32 / 16
110 / 55.5 / 125	110 / 55.5 / 125

Ordering data

Screw connection

Type	Qty.	Order No.
CP DM 10	1	8710620000

Type	Qty.	Order No.
CP DM 20	1	8768650000

Note

Note

Note

Accessories

Note

Note

Note

Small metal foot



Type	Order No.
MTA 30 MF	1251320000

Large metal foot



Type	Order No.
MTA 45 MF	1251310000

Small plastic foot



Type	Order No.
MTA 30 BK	1168970000

Large plastic foot



Type	Order No.
MTA 45 BK	1962250000

Small wall mounting



Type	Order No.
CP A WALLADAPTER 30 MM	1461870000

Large wall mounting



Type	Order No.
CP A WALLADAPTER 45 MM	1461850000

Small screwdriver



Type	Blade type	Size/AF	a	b	c	Order No.
SDIK PH1		1.00			80	9008570000
SDIS 0.5X3.0X100	B		0.5	3	100	9008380000

Markers



Type	Colour	Qty.	Order No.
SM 18/9.5 K MC NE WS	white	200	1248580000

End bracket

For DIN rail TS 35



Polyamide with fibre glass, screwable	Colour	Torque	Qty.	Order No.
WEW 35/1 SW	black	1.2 Nm	50	1162600000

connectPower PRO-M

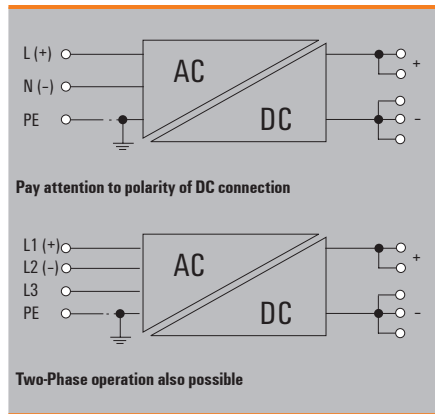

Technical data

General technical data	
Current limiting	> 120 % I _R
Ambient temp. operating / storage temperature	-25 °C...+70 °C / -40 °C... +85 °C
Max. perm. air humidity (operation)	5 %...95 % RH
Degree of protection	IP 20
Class of protection	I, with PE connection
Pollution degree	2
Insulation voltage input/output	3 kV E/A / 2 kV E/earth / 0.5 kV A/earth
MTBF	> 500,000 h acc. to IEC 1709 (SN29500)
Protection against reverse voltages from the load	30...35 V DC
Parallel connection option	yes, without diode module
Housing version	metal, corrosion resistant
Indication	operation, green LED
Mounting position, installation notice	horizontal on mounting rail TS35, 50 mm spacing top and bottom for free air circulation, can be mounted side by side with no space in between
EMC / shock / vibration	
Noise emission acc. to EN55022	Class B
Noise immunity tests acc. to	EN61000-4-2 (ESD), EN61000-4-3 and EN61000-4-8 (Fields), EN61000-4-4 (Burst), EN61000-4-5 (Surge), EN61000-4-6 (conducted), EN61000-4-11 (Dips)
Limiting of mains voltage harmonic currents	Acc. to EN61000-3-2
Resistance against vibration and shock	Acc. to EN50178, shock: 30 g in all directions
Vibration resistance	1g acc. to EN60068-2-6
Electrical safety (applied standards)	
Electrical equipment of machines	Acc. to EN60204
Safety transformers for switched-mode power units	Acc. to EN61558-2-16
Machinery with electronic equipment	Acc. to EN50178 / VDE0160
Safety extra-low voltage	SELV acc. to EN60950, PELV acc. to EN60204
Protective separation / protection against electrical shock	VDE0100-410 / acc. to DIN57100-410
Protection against dangerous shock currents	Acc. to VDE0106-101

Max. limiting average on state current [A]

Type	Temp.	45°C	50°C	55°C	60°C	65°C	70°C
1ph 24V / 3A		3.6	3.4	3.2	3	2.6	2.3
1ph 24V / 5A		6	5.7	5.3	5	4.4	3.8
1ph 24V / 7.5A		9	8.5	8	7.5	6.6	5.6
1ph 24V / 10A		12	11.3	10.7	10	8.8	7.5
1ph 24V / 20A		24	22.7	21.3	20	17.5	15
1ph 24V / 40A		48	45.3	42.7	40	35	30
3ph 24V / 5A		6	5.7	5.3	5	4.4	3.8
3ph 24V / 10A		12	11.3	10.7	10	8.8	7.5
3ph 24V / 20A		24	22.7	21.3	20	17.5	15
3ph 24V / 40A		48	45.3	42.7	40	35	30

Project-planning data

Type	24 V / 3 A	24 V / 5 A	24 V / 7.5 A	24 V / 10 A	24 V / 20 A	24 V / 40 A	24 V / 5 A	24 V / 10 A	24 V / 20 A	24 V / 40 A	
	1 - phase						3 - phase				
Rated input voltage	100...240 V AC						3 x 400...500 V AC				
Mains voltage range	85...264 V AC						3 x 320...575 V AC				
Mains input current	1.3...0.6 A	2.1...0.9 A	2.1...0.9 A	2.8...1.2 A	5.6...2.4 A	11.1...4.7 A	0.3...0.28 A	0.55...0.5 A	1.0...0.9 A	2.5...2.0 A	
Rec. fuse [char.]	2 A / D1 / II	4 A / D1 / II	6 A / D1 / II	6 A / D1 / II	10 A / D1 / II	16 A / D1 / II	2 A / D1 / II	2 A / D1 / II	2 A / D1 / II	4 A / D1 / II	
	6 A, [B]	6 A, [B]	10 A, [B]	10 A, [B]	20 A, [B]	25 A, [B]	-	-	-	10 A, [B]	
	2...4 A, [C]	3...5 A, [C]	5...10 A, [C]	5...10 A, [C]	10...12 A, [C]	14...16 A, [C]	1...2 A, [C]	2...3 A, [C]	3...5 A, [C]	6...8 A, [C]	
Efficiency @ 230 V AC, @ 3x400 V AC	90 %	90 %	91 %	90 %	90 %	91 %	90 %	90 %	90 %	91 %	
Rated power loss [W]	8 W	13 W	18 W	27 W	53 W	95 W	13 W	27 W	53 W	95 W	
Installation width	mm	33	40	50	60	121	180	40	60	121	180
Input terminals	Screw connection										
Min./max. tightening torque	Nm	0.5...0.6			0.5...0.6		0.5...0.6	0.5...0.6	0.5...0.6		
Conductor, solid min/max	mm ²	0.5..6			0.5..6		0.08..4	0.5..6	0.5..6		
Conductor, flexible min/max	mm ²	0.5..2.5			0.5..2.5		0.5..2.5	0.5..2.5	0.5..2.5		
Conductor, AWG/kcmil min/max		26 / 12			26 / 10		28 / 12	26 / 12	26 / 12		
Output terminals	Screw connection										
Number plus/minus		2 / 2		2 / 3							
Min./max. tightening torque	Nm	0.5...0.6			0.5...0.6	0.5...0.6	0.5...0.6		0.5...0.6	0.5...0.6	
Conductor, solid min/max	mm ²	0.5..6			0.5..6	0.5..16	0.5..6		0.5..6	0.5..16	
Conductor, flexible min/max	mm ²	0.5...2.5			0.5...2.5	2.5...10	0.5..2.5		0.5..2.5	2.5...10	
Conductor, AWG/kcmil min/max		26 / 12			26 / 10	22 / 6	26 / 12		26 / 10	22 / 6	

connectPower
PRO-M



Technical data

Input	
Rated input voltage	100...240 V AC (wide-range input)
Input voltage range AC	85...264 V AC (Derating @ 100 V AC)
Frequency range AC	47...63 Hz
DC input voltage range	80...370 V DC (Derating @ 120 V DC)
AC current consumption	0.6 A @ 230 V AC / 1.1 A @ 115 V AC
DC current consumption	0.25 A @ 370 V DC / 0.7 A @ 120 V DC
Input fuse (internal) / Inrush current	Yes / max. 40 A
Recommended back-up fuse	2 A / DI, fuse 6 A, Char. B, circuit breaker 2...4 A, Char. C, circuit breaker
Output	
Rated output voltage	24 V DC ± 1 %
Output voltage	22.5...29.5 V DC (adjustable via potentiometer on front)
Residual ripple, breaking spikes	< 50 mV _{SS} @ 24 V DC, I _N
Rated (nominal) output current @ U _{Nom}	3 A @ 60 °C
Continuous output current @ 24 V DC	3.6 A @ 45 °C, 3.2 A @ 55 °C, 2.3 A @ 70 °C
Powerboost @ 24 V DC, 60 °C	3.6 A for 1 min, ED = 5 %
General data	
Degree of efficiency	90 % @ 230 V AC / 88 % @ 115 V AC
Power factor (approx.)	> 0.6 @ 230 V AC / > 0.65 @ 115 V AC
AC failure bridging time @ I _{Nom}	> 20 ms @ 230 V AC / > 20 ms @ 115 V AC
Parallel connection option	yes, max. 5
Depth x width x height	125 / 33 / 130 mm
Weight	0.57 kg
Approvals	
Approvals	CE; cULus; cURus; GL; GOSTME25; TUEV

Connection data	
Wire connection method	Screw connection
Number of terminals	3 for L/N/PE
Wire cross-section, rigid min/max	0.5 / 6 mm ²
Wire cross-section, flexible min/max	0.5 / 2.5 mm ²
Wire cross-section, AWG/kcmil min/max	26 / 12
Note	
*) Recommendation applies only to AC operation; the max. permissible operating voltage is to be observed in all cases!	

Ordering data

Type	Qty.	Order No.
CP M SNT 70W 24V 3A	1	8951330000
CP M SNT 70W 24V 3A	1	8951330010

The internal varistor found in a switch-mode power supply does not replace the necessary surge protection in a system.

Accessories

Note

CP M SNT 70W 24V 3A

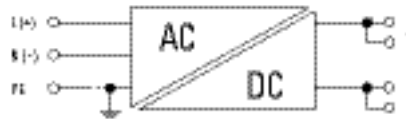

Note polarity for DC connection

CP M SNT 120W 24V 5A

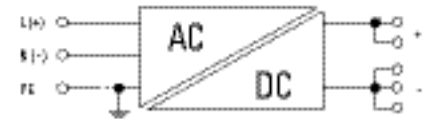

Note polarity for DC connection

Input	
Rated input voltage	100...240 V AC (wide-range input)
Input voltage range AC	85...264 V AC (Derating @ 100 V AC)
Frequency range AC	47...63 Hz
DC input voltage range	80...370 V DC (Derating @ 120 V DC)
AC current consumption	1.1 A @ 230 V AC / 2.0 A @ 115 V AC
DC current consumption	0.4 A @ 370 V DC / 1.2 A @ 120 V DC
Input fuse (internal) / Inrush current	Yes / max. 40 A
Recommended back-up fuse	4 A / DI, fuse 6 A, Char. B, circuit breaker 3...5 A, Char. C, circuit breaker
Output	
Rated output voltage	24 V DC ± 1 %
Output voltage	22.5...29.5 V DC (adjustable via potentiometer on front)
Residual ripple, breaking spikes	< 50 mV _{SS} @ 24 V DC, I _N
Rated (nominal) output current @ U _{Nom}	5 A @ 60 °C
Continuous output current @ 24 V DC	6.0 A @ 45 °C, 5.3 A @ 55 °C, 3.8 A @ 70 °C
Powerboost @ 24 V DC, 60 °C	6 A for 1 min, ED = 5 %
General data	
Degree of efficiency	90 % @ 230 V AC / 88 % @ 115 V AC
Power factor (approx.)	> 0.5 @ 230 V AC / > 0.6 @ 115 V AC
AC failure bridging time @ I _{Nom}	> 100 ms @ 230 V AC / > 20 ms @ 115 V AC
Parallel connection option	yes, max. 5
Depth x width x height	125 / 40 / 130 mm
Weight	0.7 kg
Approvals	
Approvals	CE; cULus; cURus; GL; GOSTME25; TUEV

Connection data	
Wire connection method	Screw connection
Number of terminals	5 for L/N/PE
Wire cross-section, rigid min/max	0.5 / 6 mm ²
Wire cross-section, flexible min/max	0.5 / 2.5 mm ²
Wire cross-section, AWG/kcmil min/max	26 / 12
Note	
*) Recommendation applies only to AC operation; the max. permissible operating voltage is to be observed in all cases!	

Type	Qty.	Order No.
CP M SNT 120W 24V 5A	1	8951340000
CP M SNT 120W 24V 5A	1	8951340010

The internal varistor found in a switch-mode power supply does not replace the necessary surge protection in a system.

Note

connectPower PRO-M

connectPower PRO-M



Technical data

Input	
Rated input voltage	100...240 V AC (wide-range input)
Input voltage range AC	85...264 V AC (Derating @ 100 V AC)
Frequency range AC	47...63 Hz
DC input voltage range	80...370 V DC (Derating @ 120 V DC)
AC current consumption	0.9 A @ 230 V AC / 1.8 A @ 115 V AC
DC current consumption	0.6 A @ 370 V DC / 1.7 A @ 120 V DC
Input fuse (internal) / Inrush current	Yes / max. 40 A
Recommended back-up fuse	6 A / DI, fuse 10 A, Char. B, circuit breaker 6 A, Char. C, circuit breaker
Output	
Rated output voltage	24 V DC ± 1 %
Output voltage	22.5...29.5 V DC (adjustable via potentiometer on front)
Residual ripple, breaking spikes	< 50 mV _{SS} @ 24 V DC, I _N
Rated (nominal) output current @ U _{Nom}	7,5 A @ 60 °C
Continuous output current @ 24 V DC	9.0 A @ 45 °C, 8.0 A @ 55 °C, 5.6 A @ 70 °C
Powerboost @ 24 V DC, 60 °C	9 A for 1 min, ED = 5 %
General data	
Degree of efficiency	91 % @ 230 V AC / 88 % @ 115 V AC
Power factor (approx.)	> 0.94 @ 230 V AC / > 0.99 @ 115 V AC
AC failure bridging time @ I _{Nom}	> 20 ms @ 230 V AC / > 20 ms @ 115 V AC
Parallel connection option	yes, max. 5
Depth x width x height	150 / 50 / 130 mm
Weight	1.05 kg
Approvals	
Approvals	CE; cULus; cURus; GL; GOSTME25; TUEV

Connection data	
Wire connection method	Screw connection
Number of terminals	3 for L/N/PE
Wire cross-section, rigid min/max	0.5 / 6 mm ²
Wire cross-section, flexible min/max	0.5 / 2.5 mm ²
Wire cross-section, AWG/kcmil min/max	26 / 12
Note	
*) Recommendation applies only to AC operation; the max. permissible operating voltage is to be observed in all cases!	

Ordering data

Type	Qty.	Order No.
CP M SNT 180W 24V 7,5A	1	8951350000
CP M SNT 180W 24V 7,5A	1	8951350010

Note The internal varistor found in a switch-mode power supply does not replace the necessary surge protection in a system.

Accessories

Note

CP M SNT 180W 24V 7.5A

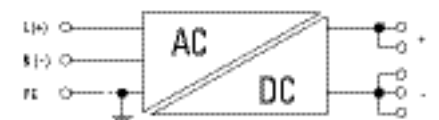

Note polarity for DC connection

CP M SNT 250W 24V 10A

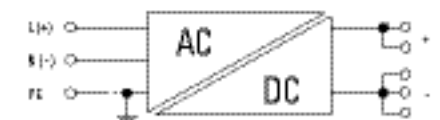

Note polarity for DC connection

Input	
Rated input voltage	100...240 V AC (wide-range input)
Input voltage range AC	85...264 V AC (Derating @ 100 V AC)
Frequency range AC	47...63 Hz
DC input voltage range	80...370 V DC (Derating @ 120 V DC)
AC current consumption	1.2 A @ 230 V AC / 2.4 A @ 115 V AC
DC current consumption	0.8 A @ 370 V DC / 2.3 A @ 120 V DC
Input fuse (internal) / Inrush current	Yes / max. 12 A
Recommended back-up fuse	4 A / DI, fuse 10 A, Char. B, circuit breaker 3...4 A, Char. C, circuit breaker
Output	
Rated output voltage	24 V DC ± 1 %
Output voltage	22.5...29.5 V DC (adjustable via potentiometer on front)
Residual ripple, breaking spikes	< 50 mV _{SS} @ 24 V DC, I _N
Rated (nominal) output current @ U _{Nom}	10 A @ 60 °C
Continuous output current @ 24 V DC	12 A @ 45 °C, 10.7 A @ 55 °C, 7.5 A @ 70 °C
Powerboost @ 24 V DC, 60 °C	12 A for 1 min, ED = 5 %
General data	
Degree of efficiency	90 % @ 230 V AC / 87 % @ 115 V AC
Power factor (approx.)	> 0.99 @ 230 V AC / > 0.97 @ 115 V AC
AC failure bridging time @ I _{Nom}	> 20 ms @ 230 V AC / > 20 ms @ 115 V AC
Parallel connection option	yes, max. 5
Depth x width x height	150 / 60 / 130 mm
Weight	1.2 kg
Approvals	
Approvals	CE; cULus; cURus; GL; GOSTME25

Input		Output	
Wire connection method	Screw connection	Wire connection method	Screw connection
Number of terminals	3 for L/N/PE	Number of terminals	5 (++) / (-)
Wire cross-section, rigid min/max	0.5 / 6 mm ²	Wire cross-section, rigid min/max	0.5 / 6 mm ²
Wire cross-section, flexible min/max	0.5 / 2.5 mm ²	Wire cross-section, flexible min/max	0.5 / 2.5 mm ²
Wire cross-section, AWG/kcmil min/max	26 / 12	Wire cross-section, AWG/kcmil min/max	26 / 12
Note			
*) Recommendation applies only to AC operation; the max. permissible operating voltage is to be observed in all cases!			

Type	Qty.	Order No.
CP M SNT 250W 24V 10A	1	8951360000
CP M SNT 250W 24V 10A	1	8951360010

Note The internal varistor found in a switch-mode power supply does not replace the necessary surge protection in a system.

connectPower
PRO-M



Technical data

Input	
Rated input voltage	100...240 V AC (wide-range input)
Input voltage range AC	85...264 V AC (Derating @ 100 V AC)
Frequency range AC	47...63 Hz
DC input voltage range	80...370 V DC (Derating @ 120 V DC)
AC current consumption	2.4 A @ 230 V AC / 4.8 A @ 115 V AC
DC current consumption	1.5 A @ 370 V DC / 4.6 A @ 120 V DC
Input fuse (internal) / Inrush current	Yes / max. 5 A
Recommended back-up fuse	6 A / DI, fuse 16 A, Char. B, circuit breaker 6...8 A, Char. C, circuit breaker
Output	
Rated output voltage	24 V DC ± 1 %
Output voltage	22.5...29.5 V DC (adjustable via potentiometer on front)
Residual ripple, breaking spikes	< 50 mV _{SS} @ 24 V DC, I _N
Rated (nominal) output current @ U _{Nom}	20 A @ 60 °C
Continuous output current @ 24 V DC	24 A @ 45 °C, 22.7 A @ 55 °C, 15 A @ 70 °C
Powerboost @ 24 V DC, 60 °C	24 A for 1 min, ED = 5 %
General data	
Degree of efficiency	90 % at 230 V AC / > 85 % at 115 V AC
Power factor (approx.)	> 0.98 @ 230 V AC / > 0.99 @ 115 V AC
AC failure bridging time @ I _{Nom}	> 20 ms @ 230 V AC / > 20 ms @ 115 V AC
Parallel connection option	yes, max. 3
Depth x width x height	150 / 121 / 130 mm
Weight	2.2 kg
Approvals	
Approvals	CE; cULus; GL; GOSTME25; TUEV

Connection data	
Wire connection method	Screw connection
Number of terminals	3 for L/N/PE
Wire cross-section, rigid min/max	0.5 / 6 mm ²
Wire cross-section, flexible min/max	0.5 / 2.5 mm ²
Wire cross-section, AWG/kcmil min/max	26 / 10
Note	
*) Recommendation applies only to AC operation; the max. permissible operating voltage is to be observed in all cases!	

Ordering data

Type	Qty.	Order No.
CP M SNT 500W 24V 20A	1	8951370000
CP M SNT 500W 24V 20A	1	8951370010

The internal varistor found in a switch-mode power supply does not replace the necessary surge protection in a system.

Accessories

Note

CP M SNT 500W 24V 20A

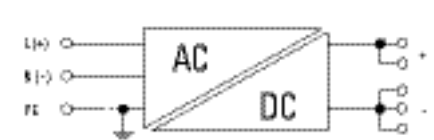

Note polarity for DC connection

Input	
Rated input voltage	100...240 V AC (wide-range input)
Input voltage range AC	85...264 V AC (Derating @ 100 V AC)
Frequency range AC	47...63 Hz
DC input voltage range	80...370 V DC (Derating @ 120 V DC)
AC current consumption	2.4 A @ 230 V AC / 4.8 A @ 115 V AC
DC current consumption	1.5 A @ 370 V DC / 4.6 A @ 120 V DC
Input fuse (internal) / Inrush current	Yes / max. 5 A
Recommended back-up fuse	6 A / DI, fuse 16 A, Char. B, circuit breaker 6...8 A, Char. C, circuit breaker
Output	
Rated output voltage	24 V DC ± 1 %
Output voltage	22.5...29.5 V DC (adjustable via potentiometer on front)
Residual ripple, breaking spikes	< 50 mV _{SS} @ 24 V DC, I _N
Rated (nominal) output current @ U _{Nom}	20 A @ 60 °C
Continuous output current @ 24 V DC	24 A @ 45 °C, 22.7 A @ 55 °C, 15 A @ 70 °C
Powerboost @ 24 V DC, 60 °C	24 A for 1 min, ED = 5 %
General data	
Degree of efficiency	90 % at 230 V AC / > 85 % at 115 V AC
Power factor (approx.)	> 0.98 @ 230 V AC / > 0.99 @ 115 V AC
AC failure bridging time @ I _{Nom}	> 20 ms @ 230 V AC / > 20 ms @ 115 V AC
Parallel connection option	yes, max. 3
Depth x width x height	150 / 121 / 130 mm
Weight	2.2 kg
Approvals	
Approvals	CE; cULus; GL; GOSTME25; TUEV

Input		Output	
Wire connection method	Screw connection	Wire connection method	Screw connection
Number of terminals	3 for L/N/PE	Number of terminals	5 (+ / -)
Wire cross-section, rigid min/max	0.5 / 6 mm ²	Wire cross-section, rigid min/max	0.5 / 6 mm ²
Wire cross-section, flexible min/max	0.5 / 2.5 mm ²	Wire cross-section, flexible min/max	0.5 / 2.5 mm ²
Wire cross-section, AWG/kcmil min/max	26 / 10	Wire cross-section, AWG/kcmil min/max	26 / 10
Note			
*) Recommendation applies only to AC operation; the max. permissible operating voltage is to be observed in all cases!			

Type	Qty.	Order No.
CP M SNT 500W 24V 20A	1	8951370000
CP M SNT 500W 24V 20A	1	8951370010

The internal varistor found in a switch-mode power supply does not replace the necessary surge protection in a system.

CP M SNT 1000W 24V 40A

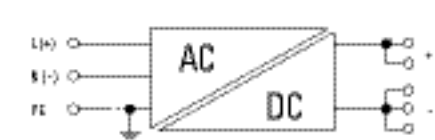

Note polarity for DC connection

Input	
Rated input voltage	100...240 V AC (wide-range input)
Input voltage range AC	85...264 V AC (Derating @ 100 V AC)
Frequency range AC	47...63 Hz
DC input voltage range	80...370 V DC (Derating @ 120 V DC)
AC current consumption	4.7 A @ 230 V AC / 9.6 A @ 115 V AC
DC current consumption	2.9 A @ 370 V DC / 9.1 A @ 120 V DC
Input fuse (internal) / Inrush current	Yes / max. 5 A
Recommended back-up fuse	16 A / DI, fuse 20 A, Char. B, circuit breaker 16 A, Char. C, circuit breaker
Output	
Rated output voltage	24 V DC ± 1 %
Output voltage	22.5...29.5 V DC (adjustable via potentiometer on front)
Residual ripple, breaking spikes	< 50 mV _{SS} @ 24 V DC, I _N
Rated (nominal) output current @ U _{Nom}	40 A @ 60 °C
Continuous output current @ 24 V DC	48 A @ 45 °C, 42.7 A @ 55 °C, 30 A @ 70 °C
Powerboost @ 24 V DC, 60 °C	48 A for 1 min, ED = 5 %
General data	
Degree of efficiency	91 % @ 230 V AC / 88 % @ 115 V AC
Power factor (approx.)	> 0.99 @ 230 V AC / > 0.99 @ 115 V AC
AC failure bridging time @ I _{Nom}	> 20 ms @ 230 V AC / > 20 ms @ 115 V AC
Parallel connection option	yes, max. 3
Depth x width x height	150 / 180 / 130 mm
Weight	3.9 kg
Approvals	
Approvals	CE; cULus; cURus; GL; GOSTME25; TUEV

Input		Output	
Wire connection method	Screw connection	Wire connection method	Screw connection
Number of terminals	3 for L/N/PE	Number of terminals	5 (+ / -)
Wire cross-section, rigid min/max	0.5 / 6 mm ²	Wire cross-section, rigid min/max	0.5 / 16 mm ²
Wire cross-section, flexible min/max	0.5 / 2.5 mm ²	Wire cross-section, flexible min/max	2.5 / 10 mm ²
Wire cross-section, AWG/kcmil min/max	26 / 10	Wire cross-section, AWG/kcmil min/max	22 / 6
Note			
*) Recommendation applies only to AC operation; the max. permissible operating voltage is to be observed in all cases!			

Type	Qty.	Order No.
CP M SNT 1000W 24V 40A	1	8951380000
CP M SNT 1000W 24V 40A	1	8951380010

The internal varistor found in a switch-mode power supply does not replace the necessary surge protection in a system.

connectPower PRO-M

connectPower PRO-M

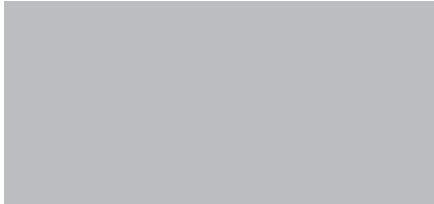

Technical data

Input	
Rated input voltage	3 x 400...3 x 500 V AC (wide-range input)
Input voltage range AC	3 x 320...3 x 575 V AC / 2 x 360...2 x 575 V AC
Frequency range AC	47...63 Hz
DC input voltage range	450...800 V DC (max. 500 V DC acc. to UL508)
AC current consumption	0.28 A @ 3 x 500 V AC / 0.3 A @ 3 x 400 V AC
DC current consumption	0.18 A @ 800 V DC / 0.3 A @ 450 V DC
Input fuse (internal) / Inrush current	Yes / max. 50 A
Recommended back-up fuse	2 A / DI, fuse 2...3 A, Char. C, circuit breaker
Output	
Rated output voltage	24 V DC ± 1 %
Output voltage	22.5...29.5 V DC (adjustable via potentiometer on front)
Residual ripple, breaking spikes	< 50 mV _{SS} @ 24 V DC, I _N
Rated (nominal) output current @ U _{Nom}	5 A @ 60 °C
Continuous output current @ 24 V DC	6.0 A @ 45 °C, 5.3 A @ 55 °C, 3.8 A @ 70 °C
Powerboost @ 24 V DC, 60 °C	6 A for 1 min, ED = 5 %
General data	
Degree of efficiency	89 % @ 3 x 500 V AC / 90 % @ 3 x 400 V AC
Power factor (approx.)	> 0.55 @ 3 x 500 V AC / > 0.65 @ 3 x 400 V AC
AC failure bridging time @ I _{Nom}	> 50 ms @ 3 x 500 V AC / > 20 ms @ 3 x 400 V AC
Parallel connection option	yes, max. 5
Depth x width x height	125 / 40 / 130 mm
Weight	0.7 kg
Approvals	
Approvals	CE; cULus; cURus; GL; GOSTME25; TUEV

Connection data	
Wire connection method	Screw connection
Number of terminals	4 for L1/L2/L3/PE
Wire cross-section, rigid min/max	0.08 / 4
Wire cross-section, flexible min/max	0.5 / 2.5
Wire cross-section, AWG/kcmil min/max	28 / 12
Note	
*) Recommendation applies only to AC operation; the max. permissible operating voltage is to be observed in all cases!	

Ordering data

Type	Qty.	Order No.
CP M SNT3 120W 24V 5A	1	8951390000
CP M SNT3 120W 24V 5A	1	8951390010

Note
The internal varistor found in a switch-mode power supply does not replace the necessary surge protection in a system.

Accessories

Note

CP M SNT3 120W 24V 5A

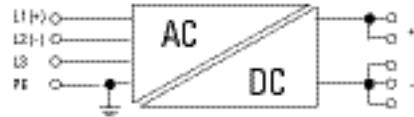

Note polarity for DC output as shown
Two-phase operation is also possible

Input	
Rated input voltage	3 x 400...3 x 500 V AC (wide-range input)
Input voltage range AC	3 x 320...3 x 575 V AC / 2 x 360...2 x 575 V AC
Frequency range AC	47...63 Hz
DC input voltage range	450...800 V DC (max. 500 V DC acc. to UL508)
AC current consumption	0.28 A @ 3 x 500 V AC / 0.3 A @ 3 x 400 V AC
DC current consumption	0.18 A @ 800 V DC / 0.3 A @ 450 V DC
Input fuse (internal) / Inrush current	Yes / max. 50 A
Recommended back-up fuse	2 A / DI, fuse 2...3 A, Char. C, circuit breaker
Output	
Rated output voltage	24 V DC ± 1 %
Output voltage	22.5...29.5 V DC (adjustable via potentiometer on front)
Residual ripple, breaking spikes	< 50 mV _{SS} @ 24 V DC, I _N
Rated (nominal) output current @ U _{Nom}	5 A @ 60 °C
Continuous output current @ 24 V DC	6.0 A @ 45 °C, 5.3 A @ 55 °C, 3.8 A @ 70 °C
Powerboost @ 24 V DC, 60 °C	6 A for 1 min, ED = 5 %
General data	
Degree of efficiency	89 % @ 3 x 500 V AC / 90 % @ 3 x 400 V AC
Power factor (approx.)	> 0.55 @ 3 x 500 V AC / > 0.65 @ 3 x 400 V AC
AC failure bridging time @ I _{Nom}	> 50 ms @ 3 x 500 V AC / > 20 ms @ 3 x 400 V AC
Parallel connection option	yes, max. 5
Depth x width x height	125 / 40 / 130 mm
Weight	0.7 kg
Approvals	
Approvals	CE; cULus; cURus; GL; GOSTME25; TUEV

Input		Output	
Wire connection method	Screw connection	Wire connection method	Screw connection
Number of terminals	4 for L1/L2/L3/PE	Number of terminals	5 (+/ -)
Wire cross-section, rigid min/max	0.08 / 4	Wire cross-section, rigid min/max	0.5 / 6
Wire cross-section, flexible min/max	0.5 / 2.5	Wire cross-section, flexible min/max	0.5 / 2.5
Wire cross-section, AWG/kcmil min/max	28 / 12	Wire cross-section, AWG/kcmil min/max	26 / 12
Note			
*) Recommendation applies only to AC operation; the max. permissible operating voltage is to be observed in all cases!			

Type	Qty.	Order No.
CP M SNT3 120W 24V 5A	1	8951390000
CP M SNT3 120W 24V 5A	1	8951390010

Note
The internal varistor found in a switch-mode power supply does not replace the necessary surge protection in a system.

CP M SNT3 250W 24V 10A

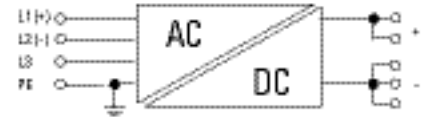

Note polarity for DC output as shown
Two-phase operation is also possible

Input	
Rated input voltage	3 x 400...3 x 500 V AC (wide-range input)
Input voltage range AC	3 x 320...3 x 575 V AC / 2 x 360...2 x 575 V AC
Frequency range AC	47...63 Hz
DC input voltage range	450...800 V DC (max. 500 V DC acc. to UL508)
AC current consumption	0.5 A @ 3 x 500 V AC / 0.55 A @ 3 x 400 V AC
DC current consumption	0.35 A @ 800 V DC / 0.6 A @ 450 V DC
Input fuse (internal) / Inrush current	Yes / max. 50 A
Recommended back-up fuse	2 A / DI, fuse 2...3 A, Char. C, circuit breaker
Output	
Rated output voltage	24 V DC ± 1 %
Output voltage	22.5...29.5 V DC (adjustable via potentiometer on front)
Residual ripple, breaking spikes	< 50 mV _{SS} @ 24 V DC, I _N
Rated (nominal) output current @ U _{Nom}	10 A @ 60 °C
Continuous output current @ 24 V DC	12 A @ 45 °C, 10.7 A @ 55 °C, 7.5 A @ 70 °C
Powerboost @ 24 V DC, 60 °C	12 A for 1 min, ED = 5 %
General data	
Degree of efficiency	89 % @ 3 x 500 V AC / 90 % @ 3 x 400 V AC
Power factor (approx.)	> 0.65 @ 3 x 500 V AC / > 0.75 @ 3 x 400 V AC
AC failure bridging time @ I _{Nom}	> 40 ms @ 3 x 500 V AC / > 20 ms @ 3 x 400 V AC
Parallel connection option	yes, max. 5
Depth x width x height	150 / 60 / 130 mm
Weight	1.25 kg
Approvals	
Approvals	CE; cULus; cURus; GL; GOSTME25; TUEV

Input		Output	
Wire connection method	Screw connection	Wire connection method	Screw connection
Number of terminals	4 for L1/L2/L3/PE	Number of terminals	5 (+/ -)
Wire cross-section, rigid min/max	0.5 / 6	Wire cross-section, rigid min/max	0.5 / 6
Wire cross-section, flexible min/max	0.5 / 2.5	Wire cross-section, flexible min/max	0.5 / 2.5
Wire cross-section, AWG/kcmil min/max	26 / 12	Wire cross-section, AWG/kcmil min/max	26 / 12
Note			
*) Recommendation applies only to AC operation; the max. permissible operating voltage is to be observed in all cases!			

Type	Qty.	Order No.
CP M SNT3 250W 24V 10A	1	8951400000
CP M SNT3 250W 24V 10A	1	8951400010

Note
The internal varistor found in a switch-mode power supply does not replace the necessary surge protection in a system.

connectPower
PRO-M



Technical data

Input	
Rated input voltage	3 x 400...3 x 500 V AC (wide-range input)
Input voltage range AC	3 x 320...3 x 575 V AC / 2 x 360...2 x 575 V AC
Frequency range AC	47...63 Hz
DC input voltage range	450...800 V DC (max. 500 V DC acc. to UL508)
AC current consumption	0.9 A @ 3 x 500 V AC / 0.95 A @ 3 x 400 V AC
DC current consumption	0.7 A @ 800 V DC / 1.2 A @ 450 V DC
Input fuse (internal) / Inrush current	Yes / max. 50 A
Recommended back-up fuse	4 A / DI, fuse 3...5 A, Char. C, circuit breaker
Output	
Rated output voltage	24 V DC ± 1 %
Output voltage	22.5...29.5 V DC (adjustable via potentiometer on front)
Residual ripple, breaking spikes	< 50 mV _{SS} @ 24 V DC, I _N
Rated (nominal) output current @ U _{nom}	20 A @ 60 °C
Continuous output current @ 24 V DC	24 A @ 45 °C, 21.3 A @ 55 °C, 15 A @ 70 °C
Powerboost @ 24 V DC, 60 °C	24 A for 1 min, ED = 5 %
General data	
Degree of efficiency	89 % @ 3 x 500 V AC / 90 % @ 3 x 400 V AC
Power factor (approx.)	< 0.69 @ 3 x 500 V AC / > 0.82 @ 3 x 400 V AC
AC failure bridging time @ I _{nom}	> 25 ms at 3 x 500 V AC / > 20 ms at 3 x 400 V AC
Parallel connection option	yes, max. 3
Depth x width x height	150 / 121 / 130 mm
Weight	2.2 kg
Approvals	
Approvals	CE; cULus; cURus; GL; GOSTME25; TUEV

Connection data	
Wire connection method	Screw connection
Number of terminals	4 for L1/L2/L3/PE
Wire cross-section, rigid min/max	0.5 / 6 mm ²
Wire cross-section, flexible min/max	0.5 / 2 mm ²
Wire cross-section, AWG/kcmil min/max	26 / 10
Note	
*) Recommendation applies only to AC operation; the max. permissible operating voltage is to be observed in all cases!	

Ordering data

Type	Qty.	Order No.
CP M SNT3 500W 24V 20A	1	8951410000
CP M SNT3 500W 24V 20A	1	8951410010

The internal varistor found in a switch-mode power supply does not replace the necessary surge protection in a system.

Accessories

Note

CP M SNT3 500W 24V 20A

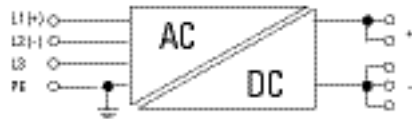

Note polarity for DC output as shown
Two-phase operation is also possible

CP M SNT3 1000W 24V 40A

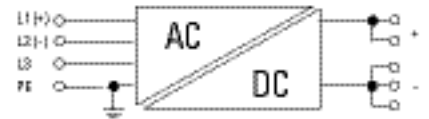

Note polarity for DC output as shown
Two-phase operation is also possible

Input	
Rated input voltage	3 x 400...3 x 500 V AC (wide-range input)
Input voltage range AC	3 x 320...3 x 575 V AC / 2 x 360...2 x 575 V AC
Frequency range AC	47...63 Hz
DC input voltage range	450...800 V DC (max. 500 V DC acc. to UL508)
AC current consumption	2.0 A @ 3 x 500 V AC / 2.5 A @ 3 x 400 V AC
DC current consumption	1.3 A @ 800 V DC / 2.4 A @ 450 V DC
Input fuse (internal) / Inrush current	Yes / max. 60 A
Recommended back-up fuse	6 A / DI, fuse 10 A, Char. B, circuit breaker 6...8 A, Char. C, circuit breaker
Output	
Rated output voltage	24 V DC ± 1 %
Output voltage	22.5...29.5 V DC (adjustable via potentiometer on front)
Residual ripple, breaking spikes	< 50 mV _{SS} @ 24 V DC, I _N
Rated (nominal) output current @ U _{nom}	40 A @ 60 °C
Continuous output current @ 24 V DC	48 A @ 45 °C, 42.7 A @ 55 °C, 30 A @ 70 °C
Powerboost @ 24 V DC, 60 °C	48 A for 1 min, ED = 5 %
General data	
Degree of efficiency	91 % @ 3 x 500 V AC / 91 % @ 3 x 400 V AC
Power factor (approx.)	> 0.6 @ 3 x 500 V AC / > 0.6 @ 3 x 400 V AC
AC failure bridging time @ I _{nom}	> 25 ms at 3 x 500 V AC / > 20 ms at 3 x 400 V AC
Parallel connection option	yes, max. 3
Depth x width x height	150 / 180 / 130 mm
Weight	4 kg
Approvals	
Approvals	CE; cULus; cURus; GL; TUEV

Connection data	
Wire connection method	Screw connection
Number of terminals	4 for L1/L2/L3/PE
Wire cross-section, rigid min/max	0.5 / 6 mm ²
Wire cross-section, flexible min/max	0.5 / 2.5 mm ²
Wire cross-section, AWG/kcmil min/max	26 / 10
Note	
*) Recommendation applies only to AC operation; the max. permissible operating voltage is to be observed in all cases!	

Type	Qty.	Order No.
CP M SNT3 1000W 24V 40A	1	8951420000
CP M SNT3 1000W 24V 40A	1	8951420010

The internal varistor found in a switch-mode power supply does not replace the necessary surge protection in a system.

connectPower PRO-M

connectPower PRO-M

CP M SNT 500W 36V 13.5A

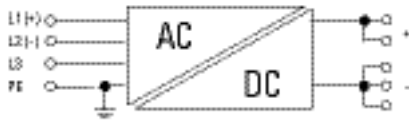
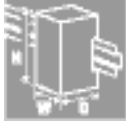

Note polarity for DC output!
Two-phase operation is also possible

Technical data

Input	
Rated input voltage	
Input voltage range AC	
Frequency range AC	
DC input voltage range	
AC current consumption	
DC current consumption	
Input fuse (internal) / Inrush current	
Recommended back-up fuse	
Output	
Rated output voltage	
Output voltage	
Residual ripple, breaking spikes	
Rated (nominal) output current @ I_{NOM}	
Continuous output current @ 24 V DC	
Powerboost @ 24 V DC, 60 °C	
General data	
Degree of efficiency	
Power factor (approx.)	
AC failure bridging time @ I_{NOM}	
Parallel connection option	
Depth x width x height	
Weight	
Approvals	
Approvals	

100...240 V AC (wide-range input)	
85...264 V AC (Derating @ 100 V AC)	
47...63 Hz	
80...370 V DC (Derating @ 120 V DC)	
2.4 A @ 230 V AC / 4.8 A @ 115 V AC	
1.5 A @ 370 V DC / 4.6 A @ 120 V DC	
Yes / 5 A	
6 A / DI, fuse	
16 A, Char. B, circuit breaker	
6...8 A, Char. C, circuit breaker	
Output	
36 V DC ± 1 %	
29...38 V DC (adjustable via potentiometer on front)	
< 50 mVss @ 36 V DC	
13.5 A @ 60°C	
General data	
90 % at 230 V AC / > 85 % at 115 V AC	
> 0.98 @ 230 V AC / > 0.99 @ 115 V AC	
> 20 ms @ 230 V AC / > 20 ms @ 115 V AC	
yes, max. 3	
150 / 121 / 130 mm	
2.2 kg	
Approvals	
CE, GOSTME25; TUEV	

Connection data	
Wire connection method	
Number of terminals	
Wire cross-section, rigid min/max	mm ²
Wire cross-section, flexible min/max	mm ²
Wire cross-section, AWG/kcmil min/max	
Note	

Input	Output
Screw connection	Screw connection
3 for L/N/PE	5 (+/ -)
0.5 / 6	0.5 / 6
0.5 / 2.5	0.5 / 2.5
26 / 10	26 / 10

*) Recommendation applies only to AC operation; the max. permissible operating voltage is to be observed in all cases!

Ordering data

	Metal clip-on foot
--	--------------------

Type	Qty.	Order No.
CP M SNT 500W 36V 13.5A	1	1412540010

Note

The internal varistor found in a switch-mode power supply does not replace the necessary surge protection in a system.

Accessories

Note

PRO-M: diode, capacity and relay modules



Technical data

Input	
Rated input voltage / DC input voltage range	
Input current	
Output	
Rated output voltage / Output voltage	
Rated (nominal) output current @ U_{nom}	
Continuous output current @ 24 V DC	
Voltage monitoring / Floating contact	
Switching thresholds	
General data	
Degree of efficiency	
Depth x width x height / Weight	
Ambient temperature (operational) / Storage temperature	
Humidity	
Protection degree / Class of protection / Pollution severity	
Insulation voltage	
MTBF	
Mounting position, installation notice	
EMC / shock / vibration	
Noise emission acc. to EN55022	
Interference immunity test acc. to	
Resistance to vibration / Shock	
Electrical safety (applied standards)	
Electrical machine equipment	
For use with electronic equipment	
Safety extra-low voltage	
Approvals	
Approvals	
Connection data	
Wire connection method	
Number of terminals	
Wire cross-section, rigid min/max	mm ²
Wire cross-section, flexible min/max	mm ²
Wire cross-section, AWG/kcmil min/max	
Note	

Ordering data

	Plastic clip-on foot
	Metal clip-on foot

Note

Accessories

Note

CP M DM20

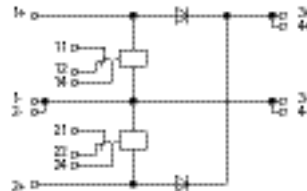

Input	
Rated input voltage / DC input voltage range	24 V DC / 18...30 V DC
Input current	2 x 10 A or 1 x 20 A
Output	
Rated output voltage / Input voltage - 0.7 V	24 V DC ± 1 % / Input voltage - 0.7 V
Rated (nominal) output current @ U_{nom}	20 A @ 60 °C
Continuous output current @ 24 V DC	24 A @ 45 °C, 22.5 A @ 55 °C, 15 A @ 70 °C
Voltage monitoring / Floating contact	Yes, In both inputs / Yes
Switching thresholds	21.6 V DC, relay is on for Power Good, 20.4 V DC, relay is off for Power Fail
General data	
Degree of efficiency	> 97% @ 24 V input voltage
Depth x width x height / Weight	150 / 34 / 130 mm / 0.3 kg
Ambient temperature (operational) / Storage temperature	-25 °C...+70 °C / -40 °C...+85 °C
Humidity	5...95 %, no condensation
Protection degree / Class of protection / Pollution severity	IP 20 / III, with no ground connection, for SELV / 2
Insulation voltage	0.5 kV <small>Input/output housing</small>
MTBF	> 500,000 h acc. to IEC 1709 (SN29500)
Mounting position, installation notice	Horizontal on TS35 DIN rail. 50 mm clearance top & bottom for air circ. Can mount side by side with no space in between.
EMC / shock / vibration	
Noise emission acc. to EN55022	Class B
Interference immunity test acc. to	EN 61000-4-2 (ESD) EN 61000-4-3 and EN 61000-4-8 (fields) EN 61000-4-4 (burst) EN 61000-4-5 (surge) EN 61000-4-6 (conducted)
Resistance to vibration / Shock	1 g according to EN50178 / 15 g In all directions
Electrical safety (applied standards)	
Electrical machine equipment	Acc. to EN60204
For use with electronic equipment	Acc. to EN50178 / VDE0160
Safety extra-low voltage	SELV acc. to EN60950, PELV acc. to EN60204
Approvals	
Approvals	cCSAus; CE; cULus; GL; GOSTME25
Connection data	
Input	Output
Screw connection	Screw connection
4 (1+, 2+, 1-, 2-)	4 (3+, 4+, 3-, 4-)
0.5 / 6	0.5 / 6
0.5 / 2.5	0.5 / 2.5
26 / 12	26 / 12

Type	Qty.	Order No.
CP M DM20	1	1222210000
CP M DM20	1	1222210010

Note

Accessories

Note

CP M DM40

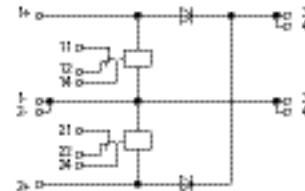

Input	
Rated input voltage / DC input voltage range	24 V DC / 18...30 V DC
Input current	2 x 20 A or 1 x 40 A
Output	
Rated output voltage / Input voltage - 0.7 V	24 V DC ± 1 % / Input voltage - 0.7 V
Rated (nominal) output current @ U_{nom}	40 A @ 60 °C
Continuous output current @ 24 V DC	48 A @ 45 °C, 45 A @ 55 °C, 30 A @ 70 °C
Voltage monitoring / Floating contact	Yes, In both inputs / Yes
Switching thresholds	21.6 V DC, relay is on for Power Good, 20.4 V DC, relay is off for Power Fail
General data	
Degree of efficiency	> 97% @ 24 V input voltage
Depth x width x height / Weight	150 / 60 / 130 mm / 0.6 kg
Ambient temperature (operational) / Storage temperature	-25 °C...+70 °C / -40 °C...+85 °C
Humidity	5...95 %, no condensation
Protection degree / Class of protection / Pollution severity	IP 20 / III, with no ground connection, for SELV / 2
Insulation voltage	0.5 kV <small>Input/output housing</small>
MTBF	> 500,000 h acc. to IEC 1709 (SN29500)
Mounting position, installation notice	Horizontal on TS35 DIN rail. 50 mm clearance top & bottom for air circ. Can mount side by side with no space in between.
EMC / shock / vibration	
Noise emission acc. to EN55022	Class B
Interference immunity test acc. to	EN 61000-4-2 (ESD) EN 61000-4-3 and EN 61000-4-8 (fields) EN 61000-4-4 (burst) EN 61000-4-5 (surge) EN 61000-4-6 (conducted)
Resistance to vibration / Shock	1 g according to EN50178 / 15 g In all directions
Electrical safety (applied standards)	
Electrical machine equipment	Acc. to EN60204
For use with electronic equipment	Acc. to EN50178 / VDE0160
Safety extra-low voltage	SELV acc. to EN60950, PELV acc. to EN60204
Approvals	
Approvals	cCSAus; CE; cULus; GL; GOSTME25
Connection data	
Input	Output
Screw connection	Screw connection
4 (1+, 2+, 1-, 2-)	4 (3+, 4+, 3-, 4-)
0.5 / 16	0.5 / 16
2.5 / 10	2.5 / 10
22 / 6	22 / 6

Type	Qty.	Order No.
CP M DM40	1	1222220000
CP M DM40	1	1222220010

Note

Accessories

Note

connectPower PRO-M

PRO-M: diode, capacity and relay modules

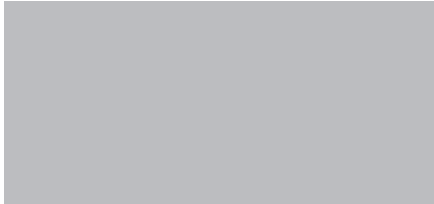

Technical data

Input	
Rated input voltage	24 V DC
DC input voltage range	18...30 V DC
Output	
Voltage monitoring	Yes
Switching thresholds	21.6 V DC, relay is on for Power Good, 20.4 V DC, relay is off for Power Fail
Floating contact	Yes
General data	
Depth x width x height	22 / 33 / 28 mm
Weight	75 kg
Ambient temperature (operational) / Storage temperature	-25 °C...+70 °C / -40 °C...+85 °C
Humidity	5...95 %, no condensation
Protection degree	IP 20
Class of protection	III, with no ground connection, for SELV
Pollution severity	2
Insulation voltage	0.5 kV <small>Input/output housing</small>
MTBF	> 500,000 h acc. to IEC 1709 (SN29500)
Mounting position, installation notice	Plugged in to the front of the PRO-M power supply
EMC / shock / vibration	
Noise emission acc. to EN55022	Class B
Interference immunity test acc. to	EN 61000-4-2 (ESD) EN 61000-4-3 and EN 61000-4-8 (fields) EN 61000-4-4 (burst) EN 61000-4-5 (surge) EN 61000-4-6 (conducted) EN 61000-4-11 (dips)
Resistance to vibration / Shock	1 g according to EN50178 / 15 g ln all directions
Electrical safety (applied standards)	
Electrical machine equipment	Acc. to EN60204
For use with electronic equipment	Acc. to EN50178 / VDE0160
Safety extra-low voltage	SELV acc. to EN60950, PELV acc. to EN60204
Approvals	
Approvals	CE; cURus; GL; GOSTME25
Connection data	
Wire connection method	PUSH IN
Number of terminals	3 (CO contacts)
Wire cross-section, rigid min/max	0.2 / 1.5
Wire cross-section, flexible min/max	0.2 / 1.5
Wire cross-section, AWG/kcmil min/max	24 / 16
Note	
Ordering data	
Note	
Accessories	
Note	

CP M RM24

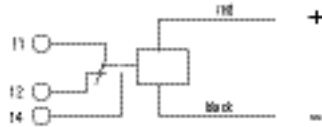

Input		
Rated input voltage	24 V DC	
DC input voltage range	18...30 V DC	
Output		
Voltage monitoring	Yes	
Switching thresholds	21.6 V DC, relay is on for Power Good, 20.4 V DC, relay is off for Power Fail	
Floating contact	Yes	
General data		
Depth x width x height	22 / 33 / 28 mm	
Weight	75 kg	
Ambient temperature (operational) / Storage temperature	-25 °C...+70 °C / -40 °C...+85 °C	
Humidity	5...95 %, no condensation	
Protection degree	IP 20	
Class of protection	III, with no ground connection, for SELV	
Pollution severity	2	
Insulation voltage	0.5 kV <small>Input/output housing</small>	
MTBF	> 500,000 h acc. to IEC 1709 (SN29500)	
Mounting position, installation notice	Plugged in to the front of the PRO-M power supply	
EMC / shock / vibration		
Noise emission acc. to EN55022	Class B	
Interference immunity test acc. to	EN 61000-4-2 (ESD) EN 61000-4-3 and EN 61000-4-8 (fields) EN 61000-4-4 (burst) EN 61000-4-5 (surge) EN 61000-4-6 (conducted) EN 61000-4-11 (dips)	
Resistance to vibration / Shock	1 g according to EN50178 / 15 g ln all directions	
Electrical safety (applied standards)		
Electrical machine equipment	Acc. to EN60204	
For use with electronic equipment	Acc. to EN50178 / VDE0160	
Safety extra-low voltage	SELV acc. to EN60950, PELV acc. to EN60204	
Approvals		
Approvals	CE; cURus; GL; GOSTME25	
Connection data		
Wire connection method	PUSH IN	PUSH IN
Number of terminals	3 (CO contacts)	
Wire cross-section, rigid min/max	0.2 / 1.5	
Wire cross-section, flexible min/max	0.2 / 1.5	
Wire cross-section, AWG/kcmil min/max	24 / 16	
Note		
Ordering data		
Type	Qty.	Order No.
CP M RM24	1	1222230000
Note		
Accessories		
Note		

PRO-M: diode, capacity and relay modules



CP M CAP

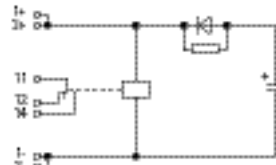

Pulse triggering for circuit breakers:

with the Weidmüller capacitance module

The following conditions apply to the table entries:

- Ambient temperature of 20 °C
- Inlet resistance of the circuit breakers is taken into account
- Half of the rated current flows to a neighboring circuit before the short circuit is formed
- DC-compatible circuit breakers: Siemens ESY series

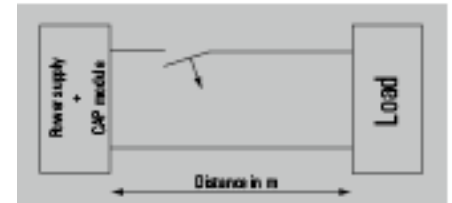

Technical data

Input	
Rated input voltage / DC input voltage range	24 V DC / 18...30 V DC
Output	
Peak current output / Recovery time for the capacitor	Depending on the load (typically 40 A for 1 ms) / Approx. 1 sec.
Switching thresholds	21.6 V DC, relay is on for Power Good, 20.4 V DC, relay is off for Power Fail
Floating contact	Yes
General data	
Depth x width x height / Weight	150 / 34 / 130 mm / 0.4 kg
Ambient temperature (operational) / Storage temperature	-25 °C...+70 °C / -40 °C...+85 °C
Humidity	5...95 %, no condensation
Protection degree	IP 20
Class of protection	III, with no ground connection, for SELV
Pollution severity	2
Insulation voltage	0.5 kV <small>input/output housing</small>
MTBF	> 500,000 h acc. to IEC 1709 (SN29500)
Mounting position, installation notice	Horizontal on TS35 DIN rail. 50 mm clearance top & bottom for air circ. Can mount side by side with no space in between.
EMC / shock / vibration	
Noise emission acc. to EN55022	Class B
Interference immunity test acc. to	EN 61000-4-2 (ESD) EN 61000-4-3 and EN 61000-4-8 (fields) EN 61000-4-4 (burst) EN 61000-4-5 (surge) EN 61000-4-6 (conducted) EN 61000-4-11 (dips)
Resistance to vibration / Shock	1 g according to EN50178 / 15 g ln all directions
Electrical safety (applied standards)	
Electrical machine equipment	Acc. to EN60204
For use with electronic equipment	Acc. to EN50178 / VDE0160
Safety extra-low voltage	SELV acc. to EN60950, PELV acc. to EN60204
Approvals	
Approvals	CE; cULus; GL

Fuse tripping

Conductor cross section	B5	B10
0.75 mm ²	10 m	6 m
1.0 mm ²	14 m	8 m
1.5 mm ²	20 m	9 m
2.5 mm ²	30 m	15 m
4 mm ²	50 m	24 m
6 mm ²		
B16		
0.75 mm ²		
1.0 mm ²		
1.5 mm ²	4 m	
2.5 mm ²	6 m	
4 mm ²	10 m	
6 mm ²	16 m	
C2 C4		
0.75 mm ²	11 m	6 m
1.0 mm ²	14 m	8 m
1.5 mm ²	21 m	12 m
2.5 mm ²	34 m	19 m
4 mm ²		32 m
6 mm ²		
C5 C10		
0.75 mm ²	3 m	
1.0 mm ²	3.5 m	2 m
1.5 mm ²	5.5 m	3 m
2.5 mm ²	9 m	5 m
4 mm ²	14 m	8 m
6 mm ²		12 m

Connection data	
Wire connection method	Screw connection
Number of terminals	3 (CO contacts)
Wire cross-section, rigid min/max	0.5 / 6
Wire cross-section, flexible min/max	0.5 / 4
Wire cross-section, AWG/kcmil min/max	26 / 12
Note	
For low-impedance connections we recommend 2.5 mm ² .	

Input	Output
Screw connection	Screw connection
4 (++-)	3 (CO contacts)
0.5 / 6	0.5 / 6
0.5 / 4	0.5 / 2.5
26 / 12	26 / 12
For low-impedance connections we recommend 2.5 mm ² .	

Ordering data

Plastic clip-on foot	
Metal clip-on foot	

Type	Qty.	Order No.
CP M CAP	1	1222240000
CP M CAP	1	1222240010

Note

Accessories

Note

PRO-M: Application solution for wind power
Switched-mode power supply with wide-range input

Application solution for wind power:

- 80 ... 430 V DC input
- Alarm contact
- Metal snap-on foot

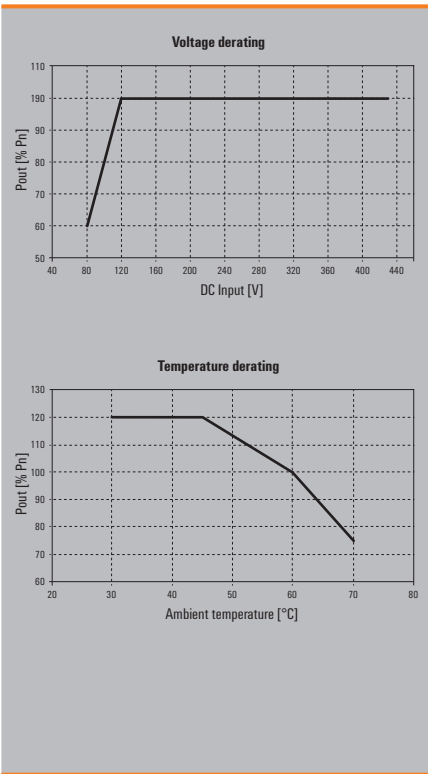

Technical data

General technical data	
Output characteristic curve / current limit	I _U / > 120 % I _n
Earth discharge current	< 3.5 mA
Ambient temperature (operational) / Storage temperature / Start-up	-25 °C...+70 °C / -40 °C...+85 °C / ≥ -40 °C
Max. permitted humidity (operational)	5 %...95 % RH
Degree of protection	IP 20
Class of protection	I, with PE connection
Pollution degree	2
Insulation voltage	3 kV AC 1 min. / 2 kV AC 1 min. / 0.5 kV AC 1 min.
MTBF	> 500,000 h according to IEC 1709 (SN29500)
Protection against reverse voltages from the load	30...35 V DC
Can be connected in parallel	Yes, without diode module
Housing version	Metal, corrosion resistant
Signal indication	Operations, green/red LED
Mounting position, installation notice	Horizontal on TS 35 mounting rail, with 50 mm of clearance at top and bottom for air circulation. Can be mounted side by side with no space in between. Suitable for installation in rotating systems.
EMC / shock / vibration	
Noise emission acc. to EN55022	Class B
Noise immunity tests acc. to	EN61000-4-2 (ESD), EN61000-4-3 and EN61000-4-8 (Fields), EN61000-4-4 (Burst), EN61000-4-5 (Surge), EN61000-4-6 (conducted), EN61000-4-11 (Dips)
Limiting of mains voltage harmonic currents	according to EN61000-3-2
Resistance against vibration and shock	according to EN50178, Shock: 5 g in all directions
Electrical safety (applied standards)	
Electrical equipment of machines	according to EN60204
Safety transformers for switched-mode power units	according to EN61558-2-17
Safety transformers for switched-mode power units	according to EN50178 / VDE0160
Safety extra low voltage	SELV according to EN60950, PELV according to EN60204
Protective separation / protection against electrical shock	VDE0100-410 / according to DIN57100-410
Protection against dangerous shock currents	according to VDE0106-101

PRO-M: application solutions for wind power



CP M SNT 250W 24V 10A UW

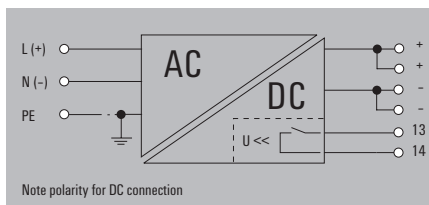

Technical data

Input

Rated input voltage / Input voltage range AC
 Frequency range AC
 DC input voltage range
 AC current consumption
 DC current consumption
 Input fuse (internal)
 Recommended back-up fuse

100..240 V AC (wide-range input) / 85..264 V AC (Derating @ 100 V AC)
 47..63 Hz
 80..430 V DC
 1.2 A @ 230 V AC / 2.4 A @ 115 V AC
 0.8 A @ 370 V DC / 2.3 A @ 120 V DC
 Yes
 4 A / DI, fuse
 10 A, Char. B, circuit breaker
 3...4 A, Char. C, circuit breaker

Output

Rated output voltage
 Output voltage
 Residual ripple, breaking spikes
 Rated (nominal) output current @ U_{nom}
 Continuous output current @ 24 V DC

24 V DC \pm 1 %
 22.5..29.5 V DC (adjustable via potentiometer on front)
 < 50 mV_{SS} @ 24 V DC, I_{lv} < 2.4 V_{SS} @ 24 V DC, I_{lv} 40 °C
 10 A @ 60 °C
 12 A @ 45 °C, 10.7 A @ 55 °C, 7.5 A @ 70 °C

General data

Degree of efficiency
 Power factor (approx.)
 AC failure bridging time @ I_{nom}
 Depth x width x height / Weight

90 % @ 230 V AC / 87 % @ 115 V AC
 > 0.99 @ 230 V AC / > 0.97 @ 115 V AC
 > 20 ms @ 230 V AC / > 20 ms @ 115 V AC
 155 / 60 / 130 mm / 1.2 Kg

Additional equipment

Status indicator
 Relay on/off

Green LED, Red LED
 Output voltage > 21.6 V / < 20.4 V

Approvals

Approvals

CE; cULus; GL; GOSTME25; TUEV

Connection data

Wire connection method
 Number of terminals
 Wire cross-section, rigid min/max mm^2
 Wire cross-section, flexible min/max mm^2
 Wire cross-section, AWG/kcmil min/max

Input

Screw connection
 3 for L/N/PE
 0.5 / 6
 0.5 / 2.5
 26 / 12

Output

Screw connection
 6 (+, +, -, COM, NO)
 0.5 / 6
 0.5 / 2.5
 26 / 12

Note

Ordering data

Type	Qty.	Order No.
CP M SNT 250W 24V 10AUW	1	1165480010

Note

The internal varistor found in a switch-mode power supply does not replace the necessary surge protection in a system.

Accessories

Note

Small metal foot



Type	Order No.
MTA 30 MF	1251320000

Large metal foot



Type	Order No.
MTA 45 MF	1251310000

Small plastic foot



Type	Order No.
MTA 30 BK	1168970000

Large plastic foot



Type	Order No.
MTA 45 BK	1962250000

Small wall mounting



Type	Order No.
CP A WALLADAPTER 30 MM	1461870000

Large wall mounting



Type	Order No.
CP A WALLADAPTER 45 MM	1461850000

Small screwdriver



Type	Blade type	Size/AF	a	b	c	Order No.
SDIK PH1		1.00			80	9008570000
SDIS 0.5X3.0X100	B		0.5	3	100	9008380000

Large screwdriver

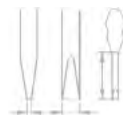
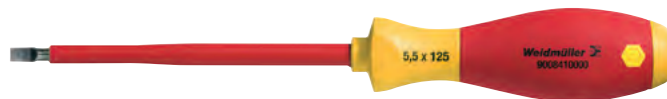

Type	Blade type	Size/AF	a	b	c	Order No.
SDIS 1.0X5.5X125	B		1	5.5	125	9008410000

Markers



Type	Colour	Qty.	Order No.
SM 18/9.5 K MC NE WS	white	200	1248580000

Endwinkel

For DIN rail TS 35



Type	Colour	Torque	Qty.	Order No.
Polyamide with fibre glass, screwable WEW 35/1 SW	black	1.2 Nm	50	1162600000

connectPower PRO-H



Technical data

General technical data	
Current limiting	> 100 % I _{rated}
Ambient temp. operating / storage temperature	-25...+70 °C -25...+85 °C
Max. perm. air humidity (operation)	95 % RH
Degree of protection / Class of protection	IP 20 / I, with PE connection
Pollution degree	2
Insulation voltage input/output	4 kV I/O 2 kV I/earth 0.5 kV O/earth
MTBF according to IEC 61709	CP T ... 70/90 W > 1.8 Mio. h CP T ... 140 W > 1.2 Mio. h CP T ... 180/360/600 W > 0.9 Mio. h
Protection against reverse voltages from the load	16 V DC / 35 V DC / 63 V DC
Parallel connection option	yes, without diode module
Housing version	metal, corrosion resistant
Overload protection	Thermal protection, autom. restart
Short circuit protection	Unlimited, autom. restart
Indication	Dual LED Operational: Green LED; Error: Red LED
Mounting position, installation notice	Horizontal on TS 35 mounting rail, with 80 mm space at top and bottom. Side by side mounting with 50 mm clearance.
Stripping length (rated connection)	7 mm
Signal indication	
Power Good Signal	Trigger point 12 V Version 9...11 V DC 24 V Version 18...22 V DC 48 V Version 36...44 V DC
Potential free, floating signal contact	NO contact 30 V DC / 1.0 A max. for 12/24 V DC modules 48 V DC / 0.5 A max. for 36/48 V DC modules
Active output signal	70 W 11 V DC ± 1 V DC / 20 mA max. 140 W 11 V DC ± 1 V DC / 40 mA max. 90 W 22 V DC ± 2 V DC / 10 mA max. 180/360/600 W 24 V DC 22 V DC ± 2 V DC / 20 mA max. 180/360/600 W 48 V DC 44 V DC ± 4 V DC / 15 mA max.
EMC / shock / vibration	
Noise emission acc. to EN55022	Class B
Noise immunity tests acc. to	EN61000-4-2 (ESD), EN61000-4-3 and EN61000-4-8 (Fields), EN61000-4-4 (Burst), EN61000-4-5 (Surge), EN61000-4-6 (conducted), EN61000-4-11 (Dips)
Limiting of mains voltage harmonic currents	according to EN61000-3-2
Vibration IEC 60068-2-6	3 axes, Sinus, 10...55 Hz, 1 g, 1 oct./min
Shock IEC 60068-2-27	3 axes, 15 g, half sinus, 11 ms
Electrical safety (applied standards)	
Electrical equipment of machines	according to EN60204
Safety transformers for switched-mode power units	according to EN1558-2-4
Machinery with electronic equipment	according to EN50178
Safety extra low voltage	SELV according to EN60950

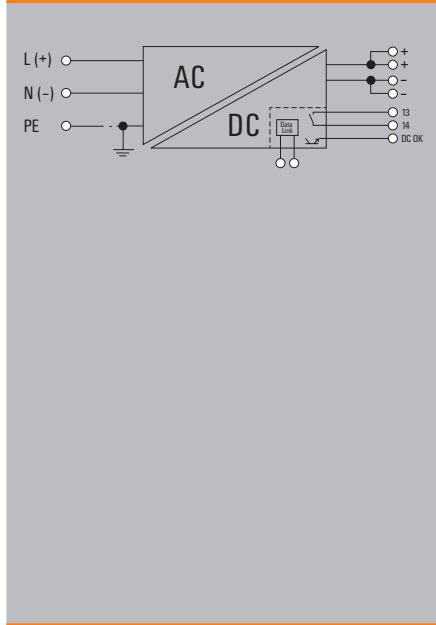

Max. limiting average on state current [A]

Type \ Temp.	40 °C	50 °C	60 °C	70 °C
1 ph 12 V / 6 A	6.0	5.7	5.4	4.5
1 ph 12 V / 12 A	12.0	9.5	7.0	3.7
1 ph 24 V / 3.8 A	3.8	3.1	2.5	1.7
1 ph 24 V / 7.5 A	7.5	6.3	5.0	3.3
1 ph 24 V / 15 A	15.0	12.5	10.0	6.7
1 ph 24 V / 25 A	25.0	22.5	20.0	13.3
1 ph 36 V / 16.5 A	16.5	15.0	13.3	9.0
1 ph 48 V / 2 A	2.0	1.6	1.3	0.8
1 ph 48 V / 4 A	4.0	3.3	2.5	1.7
1 ph 48 V / 7.5 A	7.5	6.3	5.0	3.3
1 ph 48 V / 12.5 A	12.5	11.3	10.0	7.5
1-2 ph 24 V / 7.5 A	7.5	6.3	5.0	3.3
1-2 ph 24 V / 15 A	15.0	12.5	10.0	6.7
1-2 ph 24 V / 25 A	25.0	22.5	20.0	13.3

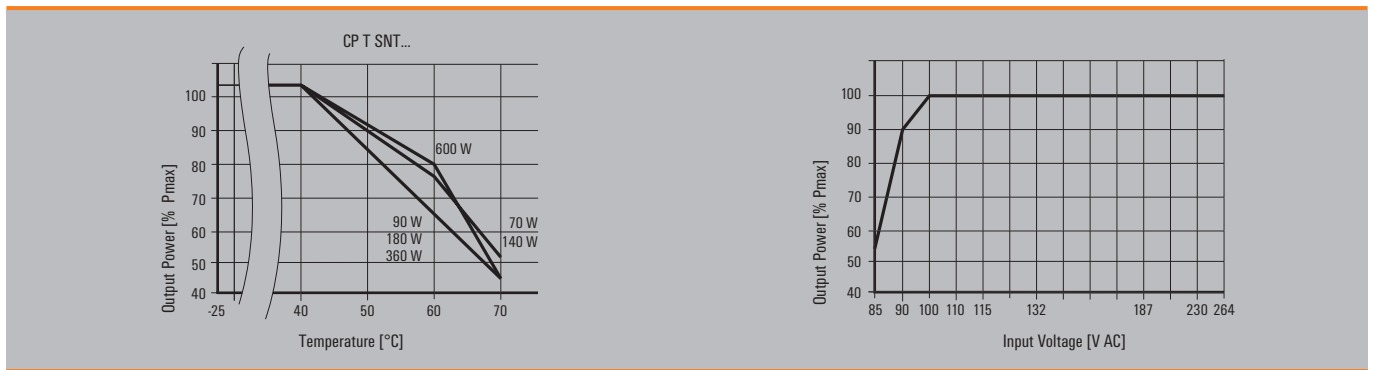

connectPower
PRO-H



CP T SNT 70W 12V 6A

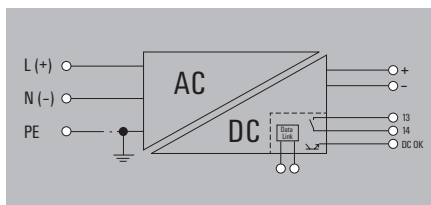

CP T SNT 140W 12V 12A

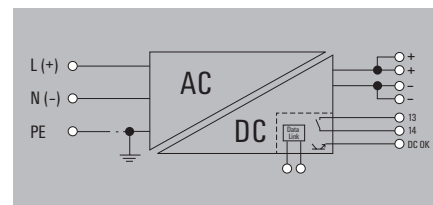

Technical data

Input	
Rated input voltage	100...240 V AC (wide-range input)
Input voltage range AC	85...264 V AC
Frequency range AC	47...63 Hz
AC current consumption	1 A @ 230 V AC, 2 A @ 115 V AC
Input fuse (internal) / Inrush current	4 A / < 20 A (230 V AC)
Recommended back-up fuse	6...16 A, char. B, circuit breaker
Output	
Rated output voltage	12 V DC ± 1 %
Output voltage	12...14 V DC (adjustable via potentiometer on front)
Residual ripple, breaking spikes	100 mV _{SS} @ 12 V DC, I _{nom}
Rated (nominal) output current @ U _{nom}	6 A @ 40 °C
Continuous output current @ 24 V DC	6 A @ 40 °C, 5.4 A @ 60 °C, 4.5 A @ 70 °C
General data	
Degree of efficiency	typ. 82 % @ 230 V AC
AC failure bridging time @ I _{nom}	min. 20 ms @ 230 V AC, min. 10 ms @ 115 V AC
Parallel connection option	yes, max. 5
Depth x width x height	110 / 35 / 110 mm
Weight	0.5 kg
Approvals	
Approvals	BVATEX; CE; CSA; cULus; cURus; GOSTME25

Input	
Rated input voltage	100...240 V AC (auto-select)
Input voltage range AC	85...132 V AC, 187...264 V AC
Frequency range AC	47...63 Hz
AC current consumption	1.4 A @ 230 V AC, 2.5 A @ 115 V AC
Input fuse (internal) / Inrush current	4 A / < 20 A (230 V AC)
Recommended back-up fuse	6...16 A, char. B, circuit breaker
Output	
Rated output voltage	12 V DC ± 1 %
Output voltage	12...14 V DC (adjustable via potentiometer on front)
Residual ripple, breaking spikes	100 mV _{SS} @ 12 V DC, I _{nom}
Rated (nominal) output current @ U _{nom}	12 A @ 40 °C
Continuous output current @ 24 V DC	12 A @ 40 °C, 7 A @ 60 °C, 3.7 A @ 70 °C
General data	
Degree of efficiency	typ. 85 % @ 230 V AC
AC failure bridging time @ I _{nom}	min. 20 ms @ 230 V AC, min. 10 ms @ 115 V AC
Parallel connection option	yes, max. 5
Depth x width x height	110 / 54 / 110 mm
Weight	0.7 kg
Approvals	
Approvals	BVATEX; CE; CSA; cULus; cURus; GOSTME25

Input	
Rated input voltage	100...240 V AC (wide-range input)
Input voltage range AC	85...264 V AC
Frequency range AC	47...63 Hz
AC current consumption	1 A @ 230 V AC, 2 A @ 115 V AC
Input fuse (internal) / Inrush current	4 A / < 20 A (230 V AC)
Recommended back-up fuse	6...16 A, char. B, circuit breaker
Output	
Rated output voltage	12 V DC ± 1 %
Output voltage	12...14 V DC (adjustable via potentiometer on front)
Residual ripple, breaking spikes	100 mV _{SS} @ 12 V DC, I _{nom}
Rated (nominal) output current @ U _{nom}	6 A @ 40 °C
Continuous output current @ 24 V DC	6 A @ 40 °C, 5.4 A @ 60 °C, 4.5 A @ 70 °C
General data	
Degree of efficiency	typ. 82 % @ 230 V AC
AC failure bridging time @ I _{nom}	min. 20 ms @ 230 V AC, min. 10 ms @ 115 V AC
Parallel connection option	yes, max. 5
Depth x width x height	110 / 35 / 110 mm
Weight	0.5 kg
Approvals	
Approvals	BVATEX; CE; CSA; cULus; cURus; GOSTME25

Connection data	
Wire connection method	Screw connection
Number of terminals	3 for L/N/PE
Wire cross-section, rigid min/max	0.5 / 2.5 mm ²
Wire cross-section, flexible min/max	0.5 / 2.5 mm ²
Wire cross-section, AWG/kcmil min/max	24 / 12
Note	

Input	Output
Wire connection method	Screw connection
Number of terminals	2 (+ / -)
Wire cross-section, rigid min/max	0.5 / 2.5
Wire cross-section, flexible min/max	0.5 / 2.5
Wire cross-section, AWG/kcmil min/max	24 / 12

Input	Output
Wire connection method	Screw connection
Number of terminals	7 (+ / - / Signal)
Wire cross-section, rigid min/max	0.5 / 2.5
Wire cross-section, flexible min/max	0.5 / 2.5
Wire cross-section, AWG/kcmil min/max	24 / 12

Ordering data

Type	Qty.	Order No.
CP T SNT 70W 12V 6A	1	1105430000

Type	Qty.	Order No.
CP T SNT 70W 12V 6A	1	1105430000

Type	Qty.	Order No.
CP T SNT 140W 12V 12A	1	1105440000

Note

The internal varistor found in a switch-mode power supply does not replace the necessary surge protection in a system.

The internal varistor found in a switch-mode power supply does not replace the necessary surge protection in a system.

Accessories

Note

connectPower PRO-H

connectPower PRO-H

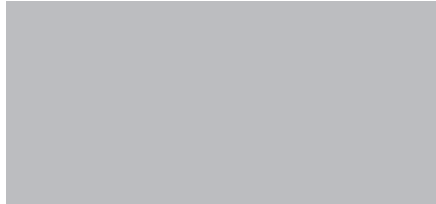
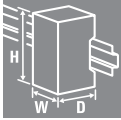

Technical data

Input	
Rated input voltage	100...240 V AC (wide-range input)
Input voltage range AC	85...264 V AC
Frequency range AC	47...63 Hz
AC current consumption	1 A @ 230 V AC, 2.1 A @ 115 V AC
Input fuse (internal) / Inrush current	4 A / < 20 A (230 V AC)
Recommended back-up fuse	6...16 A, char. B, circuit breaker
Output	
Rated output voltage	24 V DC ± 1 %
Output voltage	24...28 V DC (adjustable via potentiometer on front)
Residual ripple, breaking spikes	100 mV _{pp} @ 24 V DC, I _{load}
Rated (nominal) output current @ U _{nom}	3.8 A @ 40 °C
Continuous output current @ 24 V DC	3.8 A @ 40 °C, 2.5 A @ 60 °C, 1.7 A @ 70 °C
General data	
Degree of efficiency	typ. 85 % @ 230 V AC
AC failure bridging time @ I _{nom}	min. 20 ms @ 230 V AC, min. 10 ms @ 115 V AC
Parallel connection option	yes, max. 5
Depth x width x height	110 / 35 / 110 mm
Weight	0.5 kg
Approvals	
Approvals	BVATEX; CE; CSA; cULus; cURus; GOSTME25

Connection data	
Wire connection method	Screw connection
Number of terminals	3 for L/N/PE
Wire cross-section, rigid min/max	0.5 / 2.5 mm ²
Wire cross-section, flexible min/max	0.5 / 2.5 mm ²
Wire cross-section, AWG/kcmil min/max	24 / 12
Note	

Ordering data

Type	Qty.	Order No.
CP T SNT 90W 24V 3,8A	1	1105790000

Note
The internal varistor found in a switch-mode power supply does not replace the necessary surge protection in a system.

Accessories

Note

CP T SNT 90W 24V 3.8A

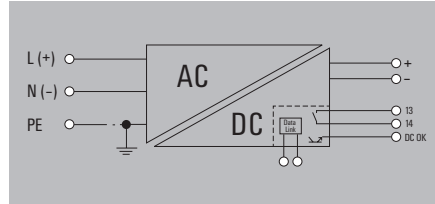

Input	
Rated input voltage	100...240 V AC (wide-range input)
Input voltage range AC	85...264 V AC
Frequency range AC	47...63 Hz
AC current consumption	1 A @ 230 V AC, 2.1 A @ 115 V AC
Input fuse (internal) / Inrush current	4 A / < 20 A (230 V AC)
Recommended back-up fuse	6...16 A, char. B, circuit breaker
Output	
Rated output voltage	24 V DC ± 1 %
Output voltage	24...28 V DC (adjustable via potentiometer on front)
Residual ripple, breaking spikes	100 mV _{pp} @ 24 V DC, I _{load}
Rated (nominal) output current @ U _{nom}	3.8 A @ 40 °C
Continuous output current @ 24 V DC	3.8 A @ 40 °C, 2.5 A @ 60 °C, 1.7 A @ 70 °C
General data	
Degree of efficiency	typ. 85 % @ 230 V AC
AC failure bridging time @ I _{nom}	min. 20 ms @ 230 V AC, min. 10 ms @ 115 V AC
Parallel connection option	yes, max. 5
Depth x width x height	110 / 35 / 110 mm
Weight	0.5 kg
Approvals	
Approvals	BVATEX; CE; CSA; cULus; cURus; GOSTME25

Input	Output
Screw connection	Screw connection
3 for L/N/PE	2 (+ / -)
0.5 / 2.5	1 / 2.5
0.5 / 2.5	0.5 / 2.5
24 / 12	24 / 12

Type	Qty.	Order No.
CP T SNT 90W 24V 3,8A	1	1105790000

Note
The internal varistor found in a switch-mode power supply does not replace the necessary surge protection in a system.

CP T SNT 90W 24V 3.8A CL2

Class 2, UL 1310

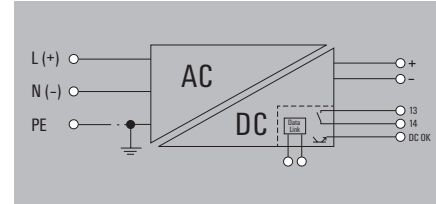

Input	
Rated input voltage	100...240 V AC (wide-range input)
Input voltage range AC	85...264 V AC
Frequency range AC	47...63 Hz
AC current consumption	1 A @ 230 V AC, 2.1 A @ 115 V AC
Input fuse (internal) / Inrush current	4 A / < 20 A (230 V AC)
Recommended back-up fuse	6...16 A, char. B, circuit breaker
Output	
Rated output voltage	24 V DC ± 1 %
Output voltage	24...28 V DC (adjustable via potentiometer on front)
Residual ripple, breaking spikes	100 mV _{pp} @ 24 V DC, I _{load}
Rated (nominal) output current @ U _{nom}	3.8 A @ 40 °C
Continuous output current @ 24 V DC	3.8 A @ 40 °C, 2.5 A @ 60 °C, 1.7 A @ 70 °C
General data	
Degree of efficiency	typ. 85 % @ 230 V AC
AC failure bridging time @ I _{nom}	min. 20 ms @ 230 V AC, min. 10 ms @ 115 V AC
Parallel connection option	yes, max. 5
Depth x width x height	110 / 35 / 110 mm
Weight	0.5 kg
Approvals	
Approvals	CE; cULus; GOSTME25

Input	Output
Screw connection	Screw connection
3 for L/N/PE	2 (+ / -)
0.5 / 2.5	1 / 2.5
0.5 / 2.5	0.5 / 2.5
24 / 12	24 / 12

Type	Qty.	Order No.
CP T SNT 90W 24V3,8ACL2	1	1194410000

Note
The internal varistor found in a switch-mode power supply does not replace the necessary surge protection in a system.

connectPower
PRO-H



CP T SNT 180W 24V 7.5A

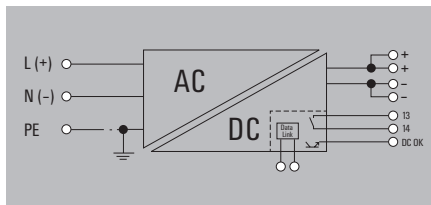

CP T SNT 360W 24V 15A

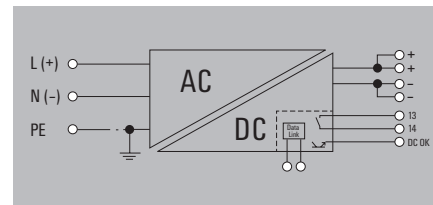

Technical data

Input	
Rated input voltage	100...240 V AC (auto-select)
Input voltage range AC	85...132 V AC, 187...264 V AC
Frequency range AC	47...63 Hz
AC current consumption	1.4 A @ 230 V AC, 2.5 A @ 115 V AC
Input fuse (internal) / Inrush current	4 A / < 20 A (230 V AC)
Recommended back-up fuse	6...16 A, char. B, circuit breaker
Output	
Rated output voltage	24 V DC ± 1 %
Output voltage	24...28 V DC (adjustable via potentiometer on front)
Residual ripple, breaking spikes	100 mV _{pp} @ 24 V DC, I _{nom}
Rated (nominal) output current @ U _{nom}	7.5 A @ 40 °C
Continuous output current @ 24 V DC	7.5 A @ 40 °C, 5 A @ 60 °C, 3.3 A @ 70 °C
General data	
Degree of efficiency	typ. 88 % @ 230 V AC
AC failure bridging time @ I _{nom}	min. 20 ms @ 230 V AC, min. 10 ms @ 115 V AC
Parallel connection option	yes, max. 5
Depth x width x height	110 / 54 / 110 mm
Weight	0.7 kg
Approvals	
Approvals	BVATEX; CE; CSA; cULus; cURus; GOSTME25

Input		Output	
Rated input voltage	100...240 V AC (auto-select)	Rated output voltage	24 V DC ± 1 %
Input voltage range AC	85...132 V AC, 187...264 V AC	Output voltage	24...28 V DC (adjustable via potentiometer on front)
Frequency range AC	47...63 Hz	Residual ripple, breaking spikes	100 mV _{pp} @ 24 V DC, I _{nom}
AC current consumption	1.4 A @ 230 V AC, 2.5 A @ 115 V AC	Rated (nominal) output current @ U _{nom}	7.5 A @ 40 °C
Input fuse (internal) / Inrush current	4 A / < 20 A (230 V AC)	Continuous output current @ 24 V DC	7.5 A @ 40 °C, 5 A @ 60 °C, 3.3 A @ 70 °C
Recommended back-up fuse	6...16 A, char. B, circuit breaker	Degree of efficiency	typ. 88 % @ 230 V AC
		AC failure bridging time @ I _{nom}	min. 20 ms @ 230 V AC, min. 10 ms @ 115 V AC
		Parallel connection option	yes, max. 5
		Depth x width x height	110 / 54 / 110 mm
		Weight	0.7 kg
		Approvals	BVATEX; CE; CSA; cULus; cURus; GOSTME25

Input		Output	
Rated input voltage	100...240 V AC (auto-select)	Rated output voltage	24 V DC ± 1 %
Input voltage range AC	85...132 V AC, 187...264 V AC	Output voltage	24...28 V DC (adjustable via potentiometer on front)
Frequency range AC	47...63 Hz	Residual ripple, breaking spikes	100 mV _{pp} @ 24 V DC, I _{nom}
AC current consumption	2.5 A @ 230 V AC, 5 A @ 115 V AC	Rated (nominal) output current @ U _{nom}	15 A @ 40 °C
Input fuse (internal) / Inrush current	6.3 A / < 25 A (230 V AC)	Continuous output current @ 24 V DC	15 A @ 40 °C, 10 A @ 60 °C, 6.7 A @ 70 °C
Recommended back-up fuse	10...16 A, char. B, circuit breaker	Degree of efficiency	typ. 87 % @ 230 V AC
		AC failure bridging time @ I _{nom}	min. 20 ms @ 230 V AC, min. 10 ms @ 115 V AC
		Parallel connection option	yes, max. 5
		Depth x width x height	110 / 80 / 110 mm
		Weight	1.1 kg
		Approvals	BVATEX; CE; CSA; cULus; cURus; GOSTME25

Connection data	
Wire connection method	Screw connection
Number of terminals	3 for L/N/PE
Wire cross-section, rigid min/max	0.5 / 2.5 mm ²
Wire cross-section, flexible min/max	0.5 / 2.5 mm ²
Wire cross-section, AWG/kcmil min/max	24 / 12
Note	

Input	Output
Wire connection method	Screw connection
Number of terminals	7 (+ / - / Signal)
Wire cross-section, rigid min/max	0.5 / 2.5
Wire cross-section, flexible min/max	0.5 / 2.5
Wire cross-section, AWG/kcmil min/max	24 / 12

Input	Output
Wire connection method	Screw connection
Number of terminals	7 (+ / - / Signal)
Wire cross-section, rigid min/max	0.5 / 2.5
Wire cross-section, flexible min/max	0.5 / 2.5
Wire cross-section, AWG/kcmil min/max	24 / 12

Ordering data

Type	Qty.	Order No.
CP T SNT 180W 24V 7,5A	1	1105810000

Type	Qty.	Order No.
CP T SNT 180W 24V 7,5A	1	1105810000

Type	Qty.	Order No.
CP T SNT 360W 24V 15A	1	1105820000

Note

The internal varistor found in a switch-mode power supply does not replace the necessary surge protection in a system.

The internal varistor found in a switch-mode power supply does not replace the necessary surge protection in a system.

Accessories

Note

connectPower PRO-H

connectPower PRO-H

CP T SNT 600W 24V 25A

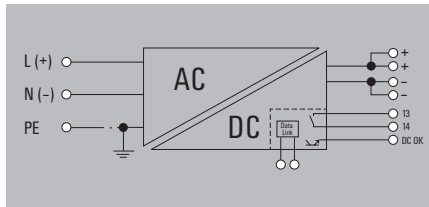
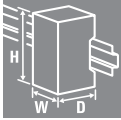

Technical data

Input
Rated input voltage
Input voltage range AC
Frequency range AC
AC current consumption
Input fuse (internal) / Inrush current
Recommended back-up fuse
Output
Rated output voltage
Output voltage
Residual ripple, breaking spikes
Rated (nominal) output current @ U_{nom}
Continuous output current @ 24 V DC
General data
Degree of efficiency
AC failure bridging time @ I_{nom}
Parallel connection option
Depth x width x height
Weight
Approvals
Approvals

100...240 V AC (auto-select)
85...132 V AC, 187...264 V AC
47...63 Hz
5 A @ 230 V AC, 10 A @ 115 V AC
12 A / < 30 A (230 V AC)
16...25 A, char. B, circuit breaker
24 V DC \pm 1 %
24...28 V DC (adjustable via potentiometer on front)
100 mV _{pp} @ 24 V DC, I_{nenn}
25 A @ 40 °C
25 A @ 40 °C, 20 A @ 60 °C, 13.3 A @ 70 °C
typ. 89 % @ 230 V AC
min. 20 ms @ 230 V AC, min. 10 ms @ 115 V AC
yes, max. 5
125 / 165 / 125 mm
2.8 kg
BVATEX; CE; CSA; cULus; cURus; GOSTME25

Connection data	
Wire connection method	
Number of terminals	
Wire cross-section, rigid min/max	mm ²
Wire cross-section, flexible min/max	mm ²
Wire cross-section, AWG/kcmil min/max	
Note	

Input	Output
Screw connection	Screw connection
3 for L/N/PE	7 (+ / - / Signal)
1 / 4	1 / 2.5
1 / 4	2.5 / 4
18 / 10	12 / 10

Ordering data

Type	Qty.	Order No.
CP T SNT 600W 24V 25A	1	1105840000

Note

The internal varistor found in a switch-mode power supply does not replace the necessary surge protection in a system.

Accessories

Note

connectPower
PRO-H



CP T SNT 90W 48V 2A

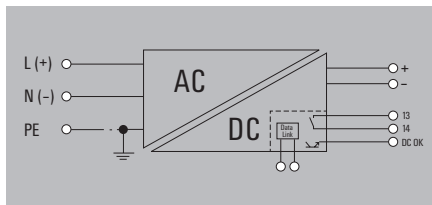

CP T SNT 180W 48V 4A

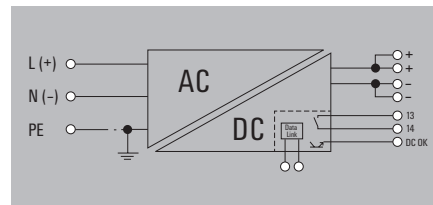

Technical data

Input	
Rated input voltage	100...240 V AC (wide-range input)
Input voltage range AC	85...264 V AC
Frequency range AC	47...63 Hz
AC current consumption	1 A @ 230 V AC, 2.1 A @ 115 V AC
Input fuse (internal) / Inrush current	4 A / < 20 A (230 V AC)
Recommended back-up fuse	6...16 A, char. B, circuit breaker
Output	
Rated output voltage	48 V DC ± 1 %
Output voltage	48...56 V DC (adjustable via potentiometer on front)
Residual ripple, breaking spikes	100 mV _{SS} @ 48 V DC, I _{Nenn}
Rated (nominal) output current @ U _{Nenn}	2 A @ 40 °C
Continuous output current @ 24 V DC	2 A @ 40 °C, 1.3 A @ 60 °C, 0.8 A @ 70 °C
General data	
Degree of efficiency	typ. 87 % @ 230 V AC
AC failure bridging time @ I _{Nenn}	min. 20 ms @ 230 V AC, min. 10 ms @ 115 V AC
Parallel connection option	yes, max. 5
Depth x width x height	110 / 35 / 110 mm
Weight	0.5 kg
Approvals	
Approvals	BVATEX; CE; cULus; GOSTME25

Input	
Rated input voltage	100...240 V AC (auto-select)
Input voltage range AC	85...132 V AC, 187...264 V AC
Frequency range AC	47...63 Hz
AC current consumption	1.4 A @ 230 V AC, 2.5 A @ 115 V AC
Input fuse (internal) / Inrush current	4 A / < 25 A (230 V AC)
Recommended back-up fuse	6...16 A, char. B, circuit breaker
Output	
Rated output voltage	48 V DC ± 1 %
Output voltage	48...56 V DC (adjustable via potentiometer on front)
Residual ripple, breaking spikes	100 mV _{SS} @ 48 V DC, I _{Nenn}
Rated (nominal) output current @ U _{Nenn}	4 A @ 40 °C
Continuous output current @ 24 V DC	4 A @ 40 °C, 2.5 A @ 60 °C, 1.7 A @ 70 °C
General data	
Degree of efficiency	typ. 90 % @ 230 V AC
AC failure bridging time @ I _{Nenn}	min. 20 ms @ 230 V AC, min. 10 ms @ 115 V AC
Parallel connection option	yes, max. 5
Depth x width x height	110 / 54 / 110 mm
Weight	0.7 kg
Approvals	
Approvals	BVATEX; CE; CSA; cULus; cURus; GOSTME25

Input	
Rated input voltage	100...240 V AC (wide-range input)
Input voltage range AC	85...264 V AC
Frequency range AC	47...63 Hz
AC current consumption	1 A @ 230 V AC, 2.1 A @ 115 V AC
Input fuse (internal) / Inrush current	4 A / < 20 A (230 V AC)
Recommended back-up fuse	6...16 A, char. B, circuit breaker
Output	
Rated output voltage	48 V DC ± 1 %
Output voltage	48...56 V DC (adjustable via potentiometer on front)
Residual ripple, breaking spikes	100 mV _{SS} @ 48 V DC, I _{Nenn}
Rated (nominal) output current @ U _{Nenn}	2 A @ 40 °C
Continuous output current @ 24 V DC	2 A @ 40 °C, 1.3 A @ 60 °C, 0.8 A @ 70 °C
General data	
Degree of efficiency	typ. 87 % @ 230 V AC
AC failure bridging time @ I _{Nenn}	min. 20 ms @ 230 V AC, min. 10 ms @ 115 V AC
Parallel connection option	yes, max. 5
Depth x width x height	110 / 35 / 110 mm
Weight	0.5 kg
Approvals	
Approvals	BVATEX; CE; cULus; GOSTME25

Connection data	
Wire connection method	Screw connection
Number of terminals	3 for L/N/PE
Wire cross-section, rigid min/max	0.5 / 2.5 mm ²
Wire cross-section, flexible min/max	0.5 / 2.5 mm ²
Wire cross-section, AWG/kcmil min/max	24 / 12
Note	

Input	Output
Screw connection	Screw connection
3 for L/N/PE	2 (+ / -)
0.5 / 2.5	1 / 2.5
0.5 / 2.5	0.5 / 2.5
24 / 12	24 / 12

Input	Output
Screw connection	Screw connection
3 for L/N/PE	7 (+ / - / Signal)
0.5 / 2.5	1 / 2.5
0.5 / 2.5	0.5 / 2.5
24 / 12	24 / 12

Ordering data

Type	Qty.	Order No.
CP T SNT 90W 48V 2A	1	1194420000

Type	Qty.	Order No.
CP T SNT 180W 48V 4A	1	1105850000

Type	Qty.	Order No.
CP T SNT 180W 48V 4A	1	1105850000

Note
The internal varistor found in a switch-mode power supply does not replace the necessary surge protection in a system.

Note
The internal varistor found in a switch-mode power supply does not replace the necessary surge protection in a system.

Note
The internal varistor found in a switch-mode power supply does not replace the necessary surge protection in a system.

Accessories

Note

Note

Note

connectPower PRO-H

connectPower PRO-H

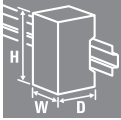

CP T SNT 360W 48V 7.5A

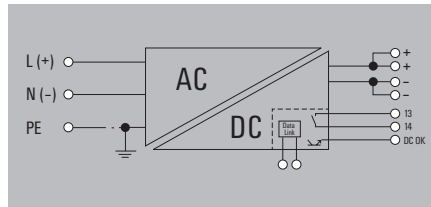

CP T SNT 600W 48V 12.5A

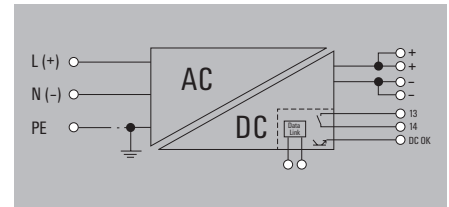

Technical data

Input	
Rated input voltage	100...240 V AC (auto-select)
Input voltage range AC	85...132 V AC, 187...264 V AC
Frequency range AC	47...63 Hz
AC current consumption	2.5 A @ 230 V AC, 5 A @ 115 V AC
Input fuse (internal) / Inrush current	6.3 A / < 25 A (230 V AC)
Recommended back-up fuse	10...16 A, char. B, circuit breaker
Output	
Rated output voltage	48 V DC ± 1 %
Output voltage	48...56 V DC (adjustable via potentiometer on front)
Residual ripple, breaking spikes	100 mV _{SS} @ 48 V DC, I _{Nenn}
Rated (nominal) output current @ U _{Nenn}	7.5 A @ 40 °C
Continuous output current @ 24 V DC	7.5 A @ 40 °C, 5 A @ 60 °C, 3.3 A @ 70 °C
General data	
Degree of efficiency	typ. 89 % @ 230 V AC
AC failure bridging time @ I _{Nenn}	min. 20 ms @ 230 V AC, min. 10 ms @ 115 V AC
Parallel connection option	yes, max. 5
Depth x width x height	125 / 80 / 125 mm
Weight	1.1 kg
Approvals	
Approvals	BVATEX; CE; CSA; cULus; cURus; GOSTME25

Input	
Rated input voltage	100...240 V AC (auto-select)
Input voltage range AC	85...132 V AC, 187...264 V AC
Frequency range AC	47...63 Hz
AC current consumption	2.5 A @ 230 V AC, 5 A @ 115 V AC
Input fuse (internal) / Inrush current	6.3 A / < 25 A (230 V AC)
Recommended back-up fuse	10...16 A, char. B, circuit breaker
Output	
Rated output voltage	48 V DC ± 1 %
Output voltage	48...56 V DC (adjustable via potentiometer on front)
Residual ripple, breaking spikes	100 mV _{SS} @ 48 V DC, I _{Nenn}
Rated (nominal) output current @ U _{Nenn}	7.5 A @ 40 °C
Continuous output current @ 24 V DC	7.5 A @ 40 °C, 5 A @ 60 °C, 3.3 A @ 70 °C
General data	
Degree of efficiency	typ. 89 % @ 230 V AC
AC failure bridging time @ I _{Nenn}	min. 20 ms @ 230 V AC, min. 10 ms @ 115 V AC
Parallel connection option	yes, max. 5
Depth x width x height	125 / 80 / 125 mm
Weight	1.1 kg
Approvals	
Approvals	BVATEX; CE; CSA; cULus; cURus; GOSTME25

Input	
Rated input voltage	100...240 V AC (auto-select)
Input voltage range AC	85...132 V AC, 187...264 V AC
Frequency range AC	47...63 Hz
AC current consumption	5 A @ 230 V AC, 10 A @ 115 V AC
Input fuse (internal) / Inrush current	12 A / < 30 A (230 V AC)
Recommended back-up fuse	16...25 A, char. B, circuit breaker
Output	
Rated output voltage	48 V DC ± 1 %
Output voltage	48...56 V DC (adjustable via potentiometer on front)
Residual ripple, breaking spikes	100 mV _{SS} @ 48 V DC, I _{Nenn}
Rated (nominal) output current @ U _{Nenn}	12.5 A @ 40 °C
Continuous output current @ 24 V DC	12.5 A @ 40 °C, 10 A @ 60 °C, 7.5 A @ 70 °C
General data	
Degree of efficiency	typ. 91 % @ 230 V AC
AC failure bridging time @ I _{Nenn}	min. 20 ms @ 230 V AC, min. 10 ms @ 115 V AC
Parallel connection option	yes, max. 5
Depth x width x height	125 / 165 / 125 mm
Weight	2.8 kg
Approvals	
Approvals	BVATEX; CE; CSA; cULus; cURus; GOSTME25

Connection data	
Wire connection method	Screw connection
Number of terminals	3 for L/N/PE
Wire cross-section, rigid min/max	0.5 / 2.5 mm ²
Wire cross-section, flexible min/max	0.5 / 2.5 mm ²
Wire cross-section, AWG/kcmil min/max	24 / 12
Note	

Input	Output
Screw connection	Screw connection
3 for L/N/PE	7 (+ / - / Signal)
0.5 / 2.5	1 / 2.5
0.5 / 2.5	1 / 2.5
24 / 12	18 / 12

Input	Output
Screw connection	Screw connection
3 for L/N/PE	7 (+ / - / Signal)
1 / 4	1 / 2.5
1 / 4	2.5 / 4
18 / 10	12 / 10

Ordering data

Type	Qty.	Order No.
CP T SNT 360W 48V 7,5A	1	1105860000

Type	Qty.	Order No.
CP T SNT 360W 48V 7,5A	1	1105860000

Type	Qty.	Order No.
CP T SNT 600W 48V 12,5A	1	1105870000

Note
The internal varistor found in a switch-mode power supply does not replace the necessary surge protection in a system.

Note
The internal varistor found in a switch-mode power supply does not replace the necessary surge protection in a system.

Note
The internal varistor found in a switch-mode power supply does not replace the necessary surge protection in a system.

Accessories

Note

Note

Note

connectPower
PRO-H



CP T SNT2 180W 24V 7.5A



CP T SNT2 360W 24V 15A

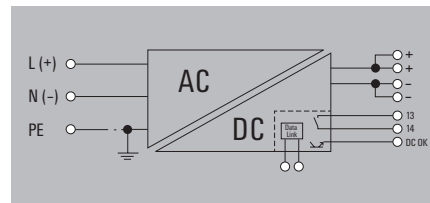
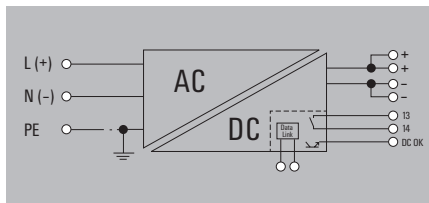

Technical data

Input	
Rated input voltage	100...500 V AC (switchable)
Input voltage range AC	85...132 V AC, 187...550 V AC
Frequency range AC	50 / 60 Hz
AC current consumption	
Input fuse (internal) / Inrush current	
Recommended back-up fuse	
Output	
Rated output voltage	24 V DC ± 1 %
Output voltage	24...28 V DC (adjustable via potentiometer on front)
Residual ripple, breaking spikes	100 mV _{pp} @ 24 V DC, I _{nom}
Rated (nominal) output current @ U _{nom}	7.5 A @ 40 °C
Continuous output current @ 24 V DC	7.5 A @ 40 °C, 5 A @ 60 °C, 3.3 A @ 70 °C
General data	
Degree of efficiency	typ. 88 %
AC failure bridging time @ I _{nom}	min. 20 ms
Parallel connection option	Yes
Depth x width x height	110 / 54 / 110 mm
Weight	0.7 kg
Approvals	
Approvals	CE

Input	
Rated input voltage	100...500 V AC (switchable)
Input voltage range AC	85...132 V AC, 187...550 V AC
Frequency range AC	50 / 60 Hz
AC current consumption	
Input fuse (internal) / Inrush current	
Recommended back-up fuse	
Output	
Rated output voltage	24 V DC ± 1 %
Output voltage	24...28 V DC (adjustable via potentiometer on front)
Residual ripple, breaking spikes	100 mV _{pp} @ 24 V DC, I _{nom}
Rated (nominal) output current @ U _{nom}	15 A @ 40 °C
Continuous output current @ 24 V DC	15 A @ 40 °C, 6.7 A @ 70 °C, 10 A @ 60 °C
General data	
Degree of efficiency	typ. 88 %
AC failure bridging time @ I _{nom}	min. 20 ms
Parallel connection option	Yes
Depth x width x height	125 / 80 / 125 mm
Weight	1.1 kg
Approvals	
Approvals	CE

Connection data	
Wire connection method	Screw connection
Number of terminals	3 for L/N/PE
Wire cross-section, rigid min/max	1 / 4 mm ²
Wire cross-section, flexible min/max	1 / 4 mm ²
Wire cross-section, AWG/kcmil min/max	18 / 10
Note	
The device is suitable for single-phase and two-phase operation.	

Input		Output	
Wire connection method	Screw connection	Wire connection method	Screw connection
Number of terminals	3 for L/N/PE	Number of terminals	4 (++) (-)
Wire cross-section, rigid min/max	1 / 4 mm ²	Wire cross-section, rigid min/max	2.5 / 4 mm ²
Wire cross-section, flexible min/max	1 / 4 mm ²	Wire cross-section, flexible min/max	2.5 / 4 mm ²
Wire cross-section, AWG/kcmil min/max	18 / 10	Wire cross-section, AWG/kcmil min/max	12 / 10
Note			
The device is suitable for single-phase and two-phase operation.			

Input		Output	
Wire connection method	Screw connection	Wire connection method	Screw connection
Number of terminals	3 for L/N/PE	Number of terminals	4 (++) (-)
Wire cross-section, rigid min/max	1 / 4 mm ²	Wire cross-section, rigid min/max	2.5 / 4 mm ²
Wire cross-section, flexible min/max	1 / 4 mm ²	Wire cross-section, flexible min/max	2.5 / 4 mm ²
Wire cross-section, AWG/kcmil min/max	18 / 10	Wire cross-section, AWG/kcmil min/max	12 / 10
Note			
The device is suitable for single-phase and two-phase operation.			

Ordering data

Type	Qty.	Order No.
CP T SNT2 180 W 24 V 7,5 A	1	1194480000

Type	Qty.	Order No.
CP T SNT2 360 W 24 V 15 A	1	1194490000

Type	Qty.	Order No.
CP T SNT2 360 W 24 V 15 A	1	1194490000

Note
The internal varistor found in a switch-mode power supply does not replace the necessary surge protection in a system.

Note
The internal varistor found in a switch-mode power supply does not replace the necessary surge protection in a system.

Note
The internal varistor found in a switch-mode power supply does not replace the necessary surge protection in a system.

Accessories

Note

Note

Note

connectPower PRO-H

connectPower PRO-H

CP T SNT2 600W 24V 25A

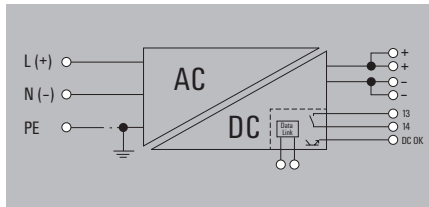
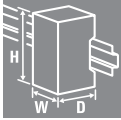

Technical data

Input
Rated input voltage
Input voltage range AC
Frequency range AC
AC current consumption
Input fuse (internal) / Inrush current
Recommended back-up fuse
Output
Rated output voltage
Output voltage
Residual ripple, breaking spikes
Rated (nominal) output current @ U_{nom}
Continuous output current @ 24 V DC
General data
Degree of efficiency
AC failure bridging time @ I_{nom}
Parallel connection option
Depth x width x height
Weight
Approvals
Approvals

100...500 V AC (switchable)
85...132 V AC, 187...550 V AC
50 / 60 Hz
/ < 50 A @ 230 V AC
24 V DC \pm 1 %
24...28 V DC (adjustable via potentiometer on front)
100 mV _{pp} @ 24 V DC, I_{nenn}
25 A @ 40 °C
25 A @ 40 °C, 20 A @ 40 °C, 13.3 A @ 70 °C
typ. 88 %
min. 20 ms
Yes
125 / 190 / 125 mm
3 kg
CE

Connection data	
Wire connection method	
Number of terminals	
Wire cross-section, rigid min/max	mm ²
Wire cross-section, flexible min/max	mm ²
Wire cross-section, AWG/kcmil min/max	
Note	

Input	Output
Screw connection	Screw connection
3 for L/N/PE	5 (++ / -)
1 / 4	2.5 / 4
1 / 4	2.5 / 4
18 / 10	12 / 10
The device is suitable for single-phase and two-phase operation.	

Ordering data

Type	Qty.	Order No.
CP T SNT2 600 W 24 V 25 A	1	1194310000

Note

The internal varistor found in a switch-mode power supply does not replace the necessary surge protection in a system.

Accessories

Note

PRO H - Accessories

Small screwdriver



Type	Blade type	Size/AF	a	b	c	Order No.
SDIK PH1		1.00			80	9008570000
SDIS 0.5X3.0X100	B		0.5	3	100	9008380000

Large screwdriver

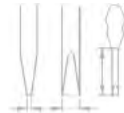

Type	Blade type	Size/AF	a	b	c	Order No.
SDIK PH2		2.00			100	9008580000
SDIS 1.0X5.5X125	B		1	5.5	125	9008410000

Markers



Type	Colour	Qty.	Order No.
SM 18/9.5 K MC NE WS	white	200	1248580000

End bracket

For DIN rail TS 35



Polyamide with fibre glass, screwable	Colour	Torque	Qty.	Order No.
WEW 35/1 SW	black	1.2 Nm	50	1162600000

PRO-H Dimensional drawings

CP T RM 10

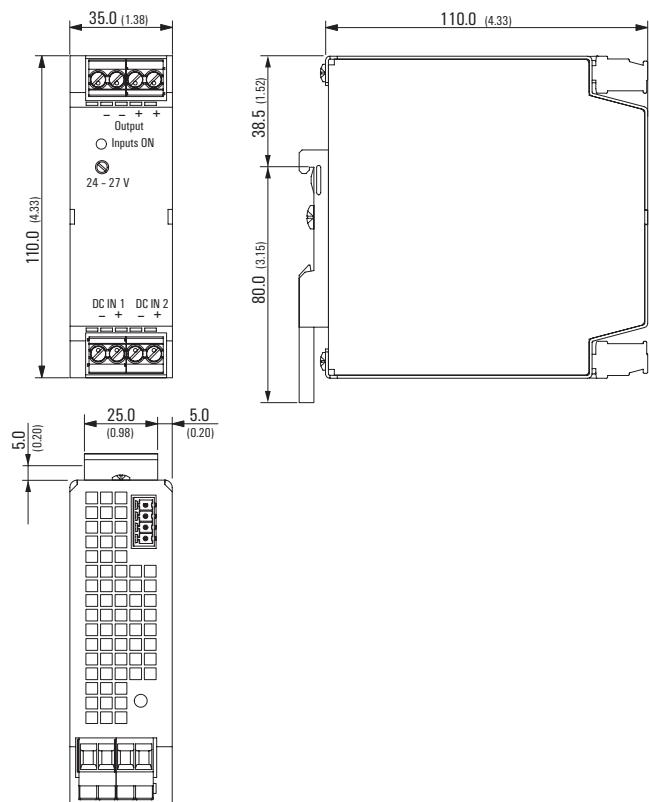

CP T RM 20

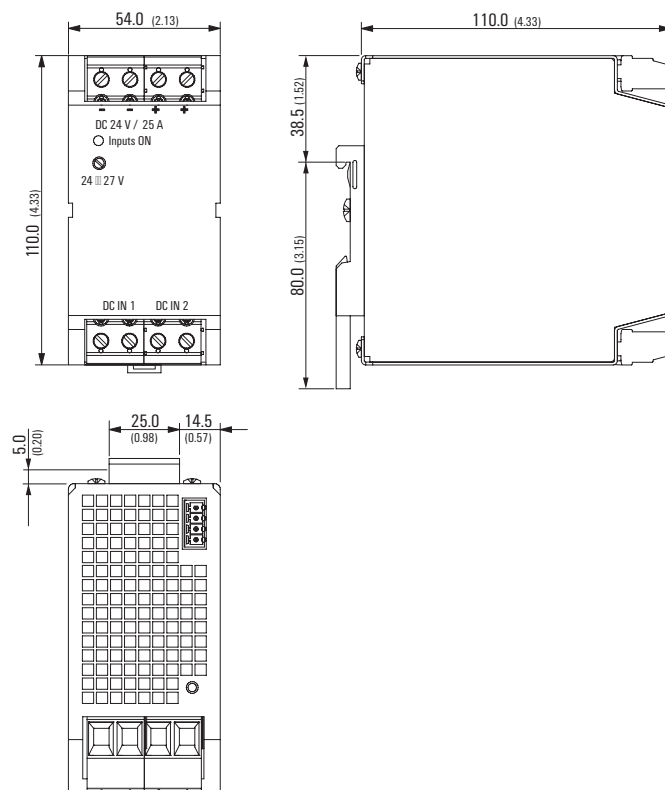

CP T SNT 70 W / 90 W

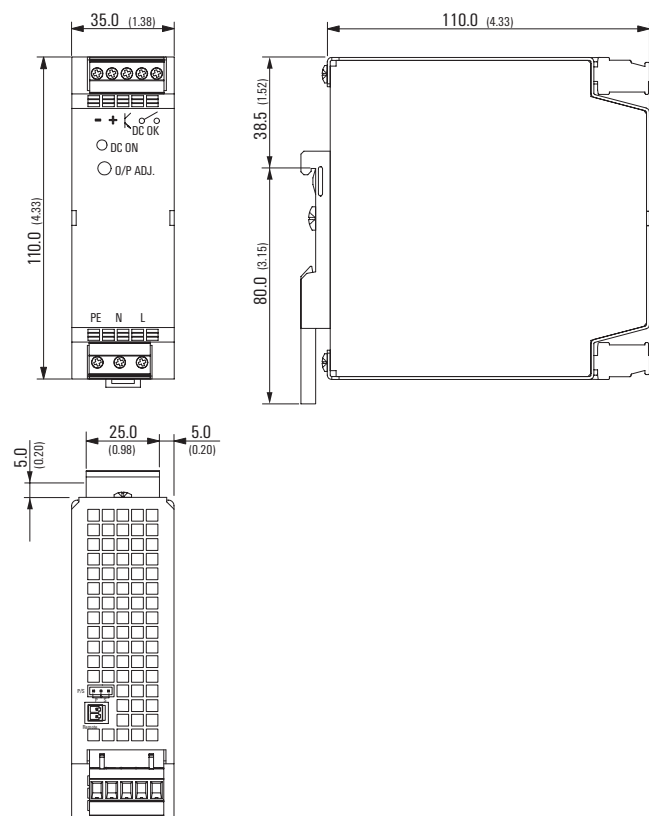

CP T SNT 180 W / 140 W

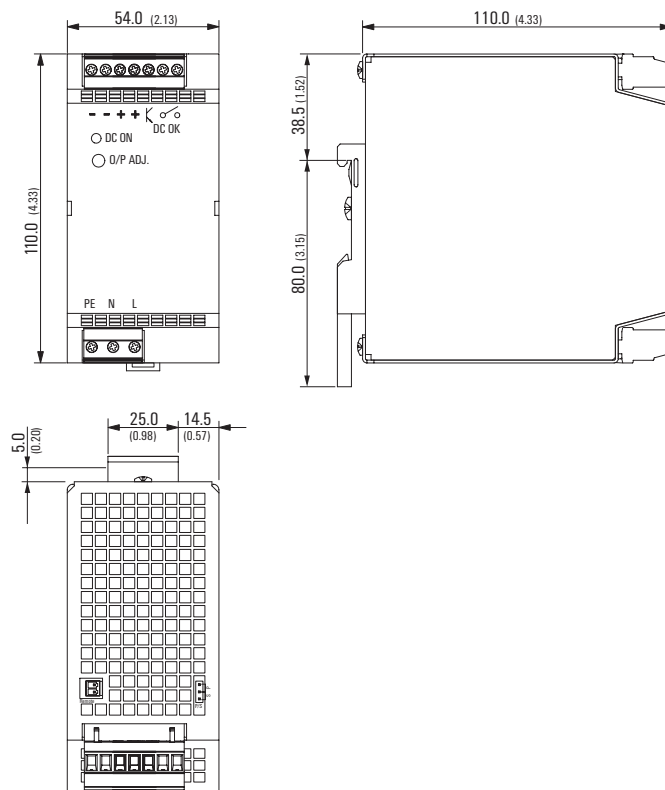

PRO-H Dimensional drawings

CP T SNT 360 W / 480 W

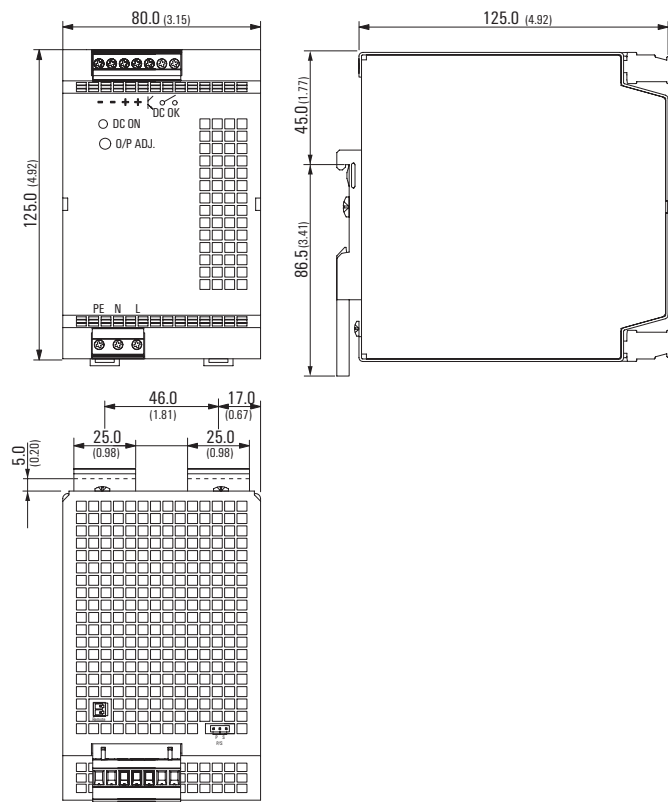

CP T SNT 600 W / 960 W

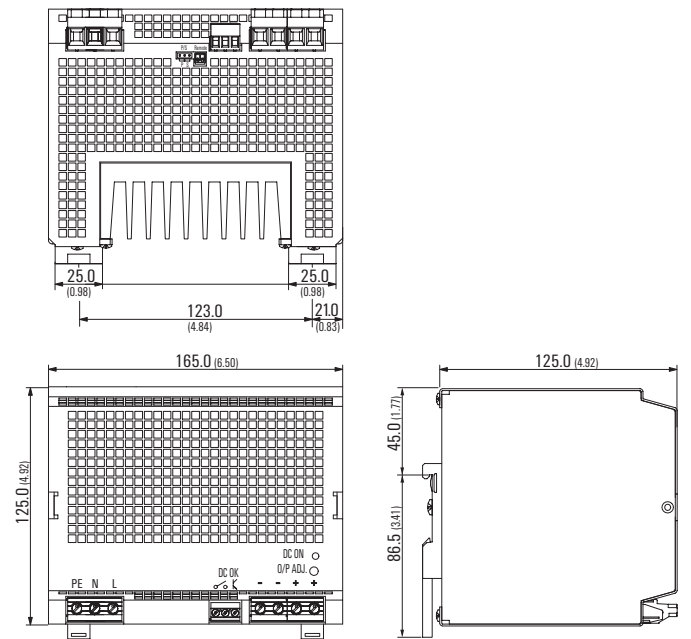

connectPower PRO-E

connectPower PRO-E

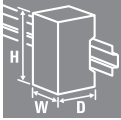

CP E SNT 25W 5V 5A



CP E SNT 25W 12V 2.1A

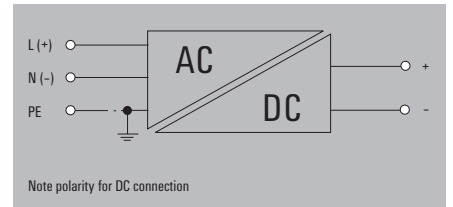
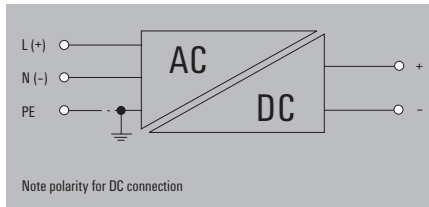

Technical data

Input	
Input voltage	85...264 V AC / 110...370 V DC
Input current	0.3 A @ 230 V AC / 0.6 A @ 120 V AC
Input frequency	47...63 Hz
Input fuse (internal)	yes / max. 20A
Recommended back-up fuse	1 A at 230 V AC, characteristic curve C
Output	
Output voltage	5 V DC
Output voltage adjustment	± 10% nominal output voltage tolerance, adjustable with potentiometer
Output current	5 A @ 5 V DC
Output power	25 W
Residual ripple, breaking spikes	< 100 mV _{pp}
Overload protection	120~150% Ikonst. of max. output power, automatic restart
Surge protection	5.6...6.8 V @ 5 V DC
Mains failure bridge-over time	20 ms
Control at 10...100% load	0.5%
Parallel connection option	Recommended with diode module
Insulation coordination	
Electrical isolation, output-earth	0.5 kV
Electrical isolation, input-earth	1.5 kV
Electrical isolation, input-output	3 kV
General data	
Ambient temperature (operational)	-20°C...70°C (>50°C derating, refer derated curve); 70% rated load@70°C
Storage temperature	-20 °C...+85 °C
Max. perm. air humidity (operational)	5 %...95 % RH
Degree of efficiency	77 % @ 5 V DC
Status indicator	Operation, green LED
Standards	EN 60950
EMC standards	EN 55011, EN 55022, EN 55024, EN 61000-6 /2, -3
Mounting position, installation notice	Panel mount, screw fix
Weight	240 g
Approvals	CE
Screw connection	
Connection cross-section, solid, min. / max.	0.34 / 4 mm ²
Depth x width x height	91 / 51 / 28 mm

Input	
Input voltage	85...264 V AC / 110...370 V DC
Input current	0.3 A @ 230 V AC / 0.6 A @ 120 V AC
Input frequency	47...63 Hz
Input fuse (internal)	yes / max. 20A
Recommended back-up fuse	1 A at 230 V AC, characteristic curve C
Output	
Output voltage	12 V DC
Output voltage adjustment	± 10% nominal output voltage tolerance, adjustable with potentiometer
Output current	2.1 A @ 12 V DC
Output power	25 W
Residual ripple, breaking spikes	< 100 mV _{pp}
Overload protection	120~150% Ikonst. of max. output power, automatic restart
Surge protection	13.5...16.2 V @ 12 V DC
Mains failure bridge-over time	20 ms
Control at 10...100% load	0.5%
Parallel connection option	Recommended with diode module
Insulation coordination	
Electrical isolation, output-earth	0.5 kV
Electrical isolation, input-earth	1.5 kV
Electrical isolation, input-output	3 kV
General data	
Ambient temperature (operational)	-20°C...70°C (>50°C derating, refer derated curve); 70% rated load@70°C
Storage temperature	-20 °C...+85 °C
Max. perm. air humidity (operational)	5 %...95 % RH
Degree of efficiency	79 % @ 12 V DC
Status indicator	Operation, green LED
Standards	EN 60950
EMC standards	EN 55011, EN 55022, EN 55024, EN 61000-6 /2, -3
Mounting position, installation notice	Panel mount, screw fix
Weight	240 g
Approvals	CE
Screw connection	
Connection cross-section, solid, min. / max.	0.34 / 4 mm ²
Depth x width x height	91 / 51 / 28 mm

Input	
Input voltage	85...264 V AC / 110...370 V DC
Input current	0.3 A @ 230 V AC / 0.6 A @ 120 V AC
Input frequency	47...63 Hz
Input fuse (internal)	yes / max. 20A
Recommended back-up fuse	1 A at 230 V AC, characteristic curve C
Output	
Output voltage	12 V DC
Output voltage adjustment	± 10% nominal output voltage tolerance, adjustable with potentiometer
Output current	2.1 A @ 12 V DC
Output power	25 W
Residual ripple, breaking spikes	< 100 mV _{pp}
Overload protection	120~150% Ikonst. of max. output power, automatic restart
Surge protection	13.5...16.2 V @ 12 V DC
Mains failure bridge-over time	20 ms
Control at 10...100% load	0.5%
Parallel connection option	Recommended with diode module
Insulation coordination	
Electrical isolation, output-earth	0.5 kV
Electrical isolation, input-earth	1.5 kV
Electrical isolation, input-output	3 kV
General data	
Ambient temperature (operational)	-20°C...70°C (>50°C derating, refer derated curve); 70% rated load@70°C
Storage temperature	-20 °C...+85 °C
Max. perm. air humidity (operational)	5 %...95 % RH
Degree of efficiency	79 % @ 12 V DC
Status indicator	Operation, green LED
Standards	EN 60950
EMC standards	EN 55011, EN 55022, EN 55024, EN 61000-6 /2, -3
Mounting position, installation notice	Panel mount, screw fix
Weight	240 g
Approvals	CE
Screw connection	
Connection cross-section, solid, min. / max.	0.34 / 4 mm ²
Depth x width x height	91 / 51 / 28 mm

Note

Ordering data

Type	Qty.	Order No.
CP E SNT 25W 5V 5A	1	1202640000

Type	Qty.	Order No.
CP E SNT 25W 12V 2.1A	1	1202630000

Note

The internal varistor found in a switch-mode power supply does not replace the necessary surge protection in a system.

The internal varistor found in a switch-mode power supply does not replace the necessary surge protection in a system.

Accessories

Note

connectPower
PRO-E



CP E SNT 25W 24V 1.1A

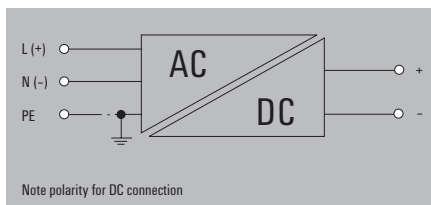

CP E SNT 25W 48V 0.57A

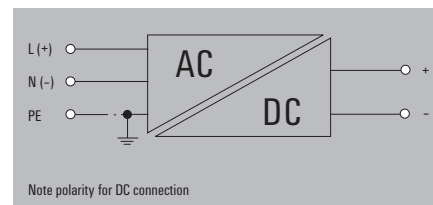

Technical data

Input	
Input voltage	85...264 V AC / 110...370 V DC
Input current	0.3 A @ 230 V AC / 0.6 A @ 120 V AC
Input frequency	47...63 Hz
Input fuse (internal)	yes / max. 20A
Recommended back-up fuse	1 A at 230 V AC, characteristic curve C
Output	
Output voltage	24 V DC
Output voltage adjustment	± 10% nominal output voltage tolerance, adjustable with potentiometer
Output current	1.1 A@24 V DC
Output power	25 W
Residual ripple, breaking spikes	< 100 mV _{pp}
Overload protection	120~150% Ikonst. of max. output power, automatic restart
Surge protection	28...32 V @ 24 V DC
Mains failure bridge-over time	20 ms
Control at 10...100% load	0.5%
Parallel connection option	Recommended with diode module
Insulation coordination	
Electrical isolation, output-earth	0.5 kV
Electrical isolation, input-earth	1.5 kV
Electrical isolation, input-output	3 kV
General data	
Ambient temperature (operational)	-20°C...70°C (>50°C derating, refer derated curve); 70% rated load@70°C
Storage temperature	-20 °C...+85 °C
Max. perm. air humidity (operational)	5 %...95 % RH
Degree of efficiency	84 % @ 24 V DC
Status indicator	Operation, green LED
Standards	EN 60950
EMC standards	EN 55011, EN 55022, EN 55024, EN 61000-6 /-2, -3
Mounting position, installation notice	Panel mount, screw fix
Weight	240 g
Approvals	CE
Screw connection	
Connection cross-section, solid, min. / max.	0.34 / 4 mm ²
Depth x width x height	91 / 51 / 28 mm

Input	
Input voltage	85...264 V AC / 110...370 V DC
Input current	0.3 A @ 230 V AC / 0.6 A @ 120 V AC
Input frequency	47...63 Hz
Input fuse (internal)	yes / max. 20A
Recommended back-up fuse	1 A at 230 V AC, characteristic curve C
Output	
Output voltage	48 V DC
Output voltage adjustment	± 10% nominal output voltage tolerance, adjustable with potentiometer
Output current	0.57 A@48 V DC
Output power	25 W
Residual ripple, breaking spikes	< 100 mV _{pp}
Overload protection	120~150% Ikonst. of max. output power, automatic restart
Surge protection	55...62 V @ 48 V DC
Mains failure bridge-over time	20 ms
Control at 10...100% load	0.5%
Parallel connection option	Recommended with diode module
Insulation coordination	
Electrical isolation, output-earth	0.5 kV
Electrical isolation, input-earth	1.5 kV
Electrical isolation, input-output	3 kV
General data	
Ambient temperature (operational)	-20°C...70°C (>50°C derating, refer derated curve); 70% rated load@70°C
Storage temperature	-20 °C...+85 °C
Max. perm. air humidity (operational)	5 %...95 % RH
Degree of efficiency	83 % @ 48 V DC
Status indicator	Operation, green LED
Standards	EN 60950
EMC standards	EN 55011, EN 55022, EN 55024, EN 61000-6 /-2, -3
Mounting position, installation notice	Panel mount, screw fix
Weight	240 g
Approvals	CE
Screw connection	
Connection cross-section, solid, min. / max.	0.34 / 4 mm ²
Depth x width x height	91 / 51 / 28 mm

Input	
Input voltage	85...264 V AC / 110...370 V DC
Input current	0.3 A @ 230 V AC / 0.6 A @ 120 V AC
Input frequency	47...63 Hz
Input fuse (internal)	yes / max. 20A
Recommended back-up fuse	1 A at 230 V AC, characteristic curve C
Output	
Output voltage	48 V DC
Output voltage adjustment	± 10% nominal output voltage tolerance, adjustable with potentiometer
Output current	0.57 A@48 V DC
Output power	25 W
Residual ripple, breaking spikes	< 100 mV _{pp}
Overload protection	120~150% Ikonst. of max. output power, automatic restart
Surge protection	55...62 V @ 48 V DC
Mains failure bridge-over time	20 ms
Control at 10...100% load	0.5%
Parallel connection option	Recommended with diode module
Insulation coordination	
Electrical isolation, output-earth	0.5 kV
Electrical isolation, input-earth	1.5 kV
Electrical isolation, input-output	3 kV
General data	
Ambient temperature (operational)	-20°C...70°C (>50°C derating, refer derated curve); 70% rated load@70°C
Storage temperature	-20 °C...+85 °C
Max. perm. air humidity (operational)	5 %...95 % RH
Degree of efficiency	83 % @ 48 V DC
Status indicator	Operation, green LED
Standards	EN 60950
EMC standards	EN 55011, EN 55022, EN 55024, EN 61000-6 /-2, -3
Mounting position, installation notice	Panel mount, screw fix
Weight	240 g
Approvals	CE
Screw connection	
Connection cross-section, solid, min. / max.	0.34 / 4 mm ²
Depth x width x height	91 / 51 / 28 mm

Note

Ordering data

Type	Qty.	Order No.
CP E SNT 25W 24V 1.1A	1	1202620000

Note

Type	Qty.	Order No.
CP E SNT 25W 48V 0.57A	1	1202610000

Note

The internal varistor found in a switch-mode power supply does not replace the necessary surge protection in a system.

The internal varistor found in a switch-mode power supply does not replace the necessary surge protection in a system.

Accessories

Note

connectPower PRO-E

connectPower PRO-E

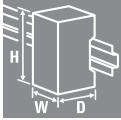

CP E SNT 50W 5V 10A



CP E SNT 50 W 12V 4.2A

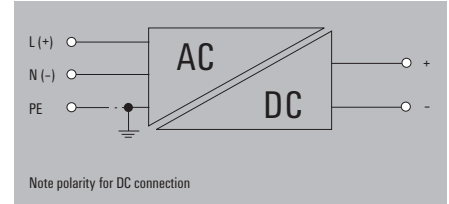
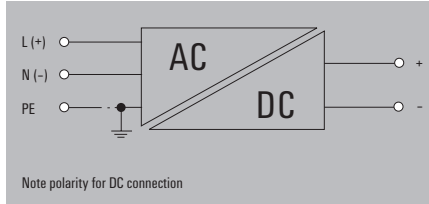

Technical data

Input	
Input voltage	85...264 V AC / 110...370 V DC
Input current	0.6 A @ 230 V AC / 1.2 A @ 120 V AC
Input frequency	47...63 Hz
Input fuse (internal)	yes / max. 20A
Recommended back-up fuse	2 A at 230 V AC, characteristic curve C
Output	
Output voltage	5 V DC
Output voltage adjustment	± 10% nominal output voltage tolerance, adjustable with potentiometer
Output current	10 A@5 V DC
Output power	50 W
Residual ripple, breaking spikes	< 100 mV _{pp}
Overload protection	120~150% Ikonst. of max. output power, automatic restart
Surge protection	5.6...6.8 V @ 5 V DC
Mains failure bridge-over time	20 ms
Control at 10...100% load	0.5%
Parallel connection option	Recommended with diode module
Insulation coordination	
Electrical isolation, output-earth	0.5 kV
Electrical isolation, input-earth	1.5 kV
Electrical isolation, input-output	3 kV
General data	
Ambient temperature (operational)	-20°C...70°C (>50°C derating, refer derated curve); 70% rated load@70°C
Storage temperature	-20 °C...+85 °C
Max. perm. air humidity (operational)	5 %...95 % RH
Degree of efficiency	78 % @ 5 V DC
Status indicator	Operation, green LED
Standards	EN 60950
EMC standards	EN 55011, EN 55022, EN 55024, EN 61000-6 /-2, -3
Mounting position, installation notice	Panel mount, screw fix
Weight	310 g
Approvals	CE
Screw connection	
Connection cross-section, solid, min. / max.	0.34 / 4 mm ²
Depth x width x height	105 / 100 / 35 mm

Input	
Input voltage	85...264 V AC / 110...370 V DC
Input current	0.6 A @ 230 V AC / 1.2 A @ 120 V AC
Input frequency	47...63 Hz
Input fuse (internal)	yes / max. 20A
Recommended back-up fuse	2 A at 230 V AC, characteristic curve C
Output	
Output voltage	12 V DC
Output voltage adjustment	± 10% nominal output voltage tolerance, adjustable with potentiometer
Output current	4.2 A@12 V DC
Output power	50 W
Residual ripple, breaking spikes	< 100 mV _{pp}
Overload protection	120~150% Ikonst. of max. output power, automatic restart
Surge protection	13.5...16.2 V @ 12 V DC
Mains failure bridge-over time	20 ms
Control at 10...100% load	0.5%
Parallel connection option	Recommended with diode module
Insulation coordination	
Electrical isolation, output-earth	0.5 kV
Electrical isolation, input-earth	1.5 kV
Electrical isolation, input-output	3 kV
General data	
Ambient temperature (operational)	-20°C...70°C (>50°C derating, refer derated curve); 70% rated load@70°C
Storage temperature	-20 °C...+85 °C
Max. perm. air humidity (operational)	5 %...95 % RH
Degree of efficiency	81 % @ 12 V DC
Status indicator	Operation, green LED
Standards	EN 60950
EMC standards	EN 55011, EN 55022, EN 55024, EN 61000-6 /-2, -3
Mounting position, installation notice	Panel mount, screw fix
Weight	310 g
Approvals	CE
Screw connection	
Connection cross-section, solid, min. / max.	0.34 / 4 mm ²
Depth x width x height	105 / 100 / 35 mm

Input	
Input voltage	85...264 V AC / 110...370 V DC
Input current	0.6 A @ 230 V AC / 1.2 A @ 120 V AC
Input frequency	47...63 Hz
Input fuse (internal)	yes / max. 20A
Recommended back-up fuse	2 A at 230 V AC, characteristic curve C
Output	
Output voltage	12 V DC
Output voltage adjustment	± 10% nominal output voltage tolerance, adjustable with potentiometer
Output current	4.2 A@12 V DC
Output power	50 W
Residual ripple, breaking spikes	< 100 mV _{pp}
Overload protection	120~150% Ikonst. of max. output power, automatic restart
Surge protection	13.5...16.2 V @ 12 V DC
Mains failure bridge-over time	20 ms
Control at 10...100% load	0.5%
Parallel connection option	Recommended with diode module
Insulation coordination	
Electrical isolation, output-earth	0.5 kV
Electrical isolation, input-earth	1.5 kV
Electrical isolation, input-output	3 kV
General data	
Ambient temperature (operational)	-20°C...70°C (>50°C derating, refer derated curve); 70% rated load@70°C
Storage temperature	-20 °C...+85 °C
Max. perm. air humidity (operational)	5 %...95 % RH
Degree of efficiency	81 % @ 12 V DC
Status indicator	Operation, green LED
Standards	EN 60950
EMC standards	EN 55011, EN 55022, EN 55024, EN 61000-6 /-2, -3
Mounting position, installation notice	Panel mount, screw fix
Weight	310 g
Approvals	CE
Screw connection	
Connection cross-section, solid, min. / max.	0.34 / 4 mm ²
Depth x width x height	105 / 100 / 35 mm

Note

Ordering data

Type	Qty.	Order No.
CP E SNT 50W 5V 10A	1	1202590000

Type	Qty.	Order No.
CP E SNT 50W 12V 4.2A	1	1202580000

Note

The internal varistor found in a switch-mode power supply does not replace the necessary surge protection in a system.

The internal varistor found in a switch-mode power supply does not replace the necessary surge protection in a system.

Accessories

Note

connectPower
PRO-E



CP E SNT 50W 24V 2.2A

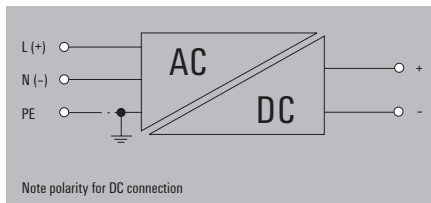

CP E SNT 50W 48V 1.1A

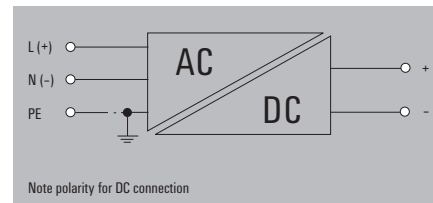

Technical data

Input	
Input voltage	85...264 V AC / 110...370 V DC
Input current	0.6 A @ 230 V AC / 1.2 A @ 120 V AC
Input frequency	47...63 Hz
Input fuse (internal)	yes / max. 20A
Recommended back-up fuse	2 A at 230 V AC, characteristic curve C
Output	
Output voltage	24 V DC
Output voltage adjustment	± 10% nominal output voltage tolerance, adjustable with potentiometer
Output current	2.2 A @ 24 V DC
Output power	50 W
Residual ripple, breaking spikes	< 100 mV _{pp}
Overload protection	120~150% Ikonst. of max. output power, automatic restart
Surge protection	28...32 V @ 24 V DC
Mains failure bridge-over time	20 ms
Control at 10...100% load	0.5%
Parallel connection option	Recommended with diode module
Insulation coordination	
Electrical isolation, output-earth	0.5 kV
Electrical isolation, input-earth	1.5 kV
Electrical isolation, input-output	3 kV
General data	
Ambient temperature (operational)	-20°C...70°C (>50°C derating, refer derated curve); 70% rated load@70°C
Storage temperature	-20 °C...+85 °C
Max. perm. air humidity (operational)	5 %...95 % RH
Degree of efficiency	84 % @ 24 V DC
Status indicator	Operation, green LED
Standards	EN 60950
EMC standards	EN 55011, EN 55022, EN 55024, EN 61000-6 /-2, -3
Mounting position, installation notice	Panel mount, screw fix
Weight	310 g
Approvals	CE
Screw connection	
Connection cross-section, solid, min. / max.	0.34 / 4 mm ²
Depth x width x height	105 / 100 / 35 mm

Output voltage	48 V DC
Output voltage adjustment	± 10% nominal output voltage tolerance, adjustable with potentiometer
Output current	1.1 A @ 48 V DC
Output power	50 W
Residual ripple, breaking spikes	< 100 mV _{pp}
Overload protection	120~150% Ikonst. of max. output power, automatic restart
Surge protection	55...62 V @ 48 V DC
Mains failure bridge-over time	20 ms
Control at 10...100% load	0.5%
Parallel connection option	Recommended with diode module
Electrical isolation, output-earth	0.5 kV
Electrical isolation, input-earth	1.5 kV
Electrical isolation, input-output	3 kV
Ambient temperature (operational)	-20°C...70°C (>50°C derating, refer derated curve); 70% rated load@70°C
Storage temperature	-20 °C...+85 °C
Max. perm. air humidity (operational)	5 %...95 % RH
Degree of efficiency	86 % @ 48 V DC
Status indicator	Operation, green LED
Standards	EN 60950
EMC standards	EN 55011, EN 55022, EN 55024, EN 61000-6 /-2, -3
Mounting position, installation notice	Panel mount, screw fix
Weight	310 g
Approvals	CE
Connection cross-section, solid, min. / max.	0.34 / 4 mm ²
Depth x width x height	105 / 100 / 35 mm

Note	
The internal varistor found in a switch-mode power supply does not replace the necessary surge protection in a system.	

Ordering data

Type	Qty.	Order No.
CP E SNT 50W 24V 2.2A	1	1202450000

Type	Qty.	Order No.
CP E SNT 50W 48V 1.1A	1	1202460000

Type	Qty.	Order No.
CP E SNT 50W 48V 1.1A	1	1202460000

Note

Accessories

Note

The internal varistor found in a switch-mode power supply does not replace the necessary surge protection in a system.

The internal varistor found in a switch-mode power supply does not replace the necessary surge protection in a system.

connectPower PRO-E

connectPower PRO-E

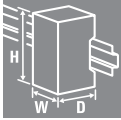

CP E SNT 75W 5V 12A

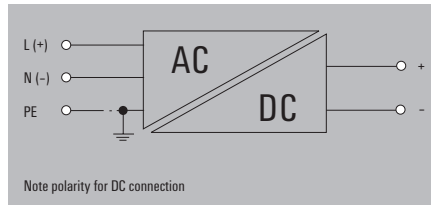

CP E SNT 75W 12V 6A

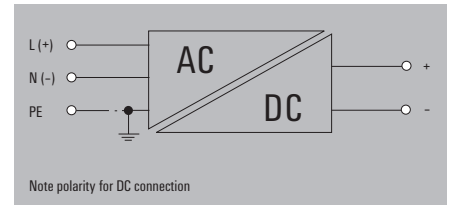

Technical data

Input	
Input voltage	85...264 V AC / 110...370 V DC
Input current	1 A @ 230 V AC / 2 A @ 120 V AC
Input frequency	47...63 Hz
Input fuse (internal)	yes / max. 20A
Recommended back-up fuse	4 A at 230 V AC, characteristic curve C
Output	
Output voltage	5 V DC
Output voltage adjustment	± 10% nominal output voltage tolerance, adjustable with potentiometer
Output current	12 A@5 V DC
Output power	75 W
Residual ripple, breaking spikes	< 100 mV _{pp}
Overload protection	120~150% lkonst. of max. output power, automatic restart
Surge protection	5.6...6.8 V @ 5 V DC
Mains failure bridge-over time	20 ms
Control at 10...100% load	0.5%
Parallel connection option	Recommended with diode module
Insulation coordination	
Electrical isolation, output-earth	0.5 kV
Electrical isolation, input-earth	1.5 kV
Electrical isolation, input-output	3 kV
General data	
Ambient temperature (operational)	-20°C...70°C (>50°C derating, refer derated curve); 70% rated load@70°C
Storage temperature	-20 °C...+85 °C
Max. perm. air humidity (operational)	5 %...95 % RH
Degree of efficiency	76 % @ 5 V DC
Status indicator	Operation, green LED
Standards	EN 60950
EMC standards	EN 55011, EN 55022, EN 55024, EN 61000-6 /-2, -3
Mounting position, installation notice	Panel mount, screw fix
Weight	440 g
Approvals	CE
Screw connection	
Connection cross-section, solid, min. / max.	0.34 / 4 mm ²
Depth x width x height	135 / 98.5 / 40 mm

Input	
Input voltage	85...264 V AC / 110...370 V DC
Input current	1 A @ 230 V AC / 2 A @ 120 V AC
Input frequency	47...63 Hz
Input fuse (internal)	yes / max. 20A
Recommended back-up fuse	4 A at 230 V AC, characteristic curve C
Output	
Output voltage	12 V DC
Output voltage adjustment	± 10% nominal output voltage tolerance, adjustable with potentiometer
Output current	6 A@12 V DC
Output power	75 W
Residual ripple, breaking spikes	< 100 mV _{pp}
Overload protection	120~150% lkonst. of max. output power, automatic restart
Surge protection	13.5...16.2 V @ 12 V DC
Mains failure bridge-over time	20 ms
Control at 10...100% load	0.5%
Parallel connection option	Recommended with diode module
Insulation coordination	
Electrical isolation, output-earth	0.5 kV
Electrical isolation, input-earth	1.5 kV
Electrical isolation, input-output	3 kV
General data	
Ambient temperature (operational)	-20°C...70°C (>50°C derating, refer derated curve); 70% rated load@70°C
Storage temperature	-20 °C...+85 °C
Max. perm. air humidity (operational)	5 %...95 % RH
Degree of efficiency	81 % @ 12 V DC
Status indicator	Operation, green LED
Standards	EN 60950
EMC standards	EN 55011, EN 55022, EN 55024, EN 61000-6 /-2, -3
Mounting position, installation notice	Panel mount, screw fix
Weight	440 g
Approvals	CE
Screw connection	
Connection cross-section, solid, min. / max.	0.34 / 4 mm ²
Depth x width x height	135 / 98.5 / 40 mm

Input	
Input voltage	85...264 V AC / 110...370 V DC
Input current	1 A @ 230 V AC / 2 A @ 120 V AC
Input frequency	47...63 Hz
Input fuse (internal)	yes / max. 20A
Recommended back-up fuse	4 A at 230 V AC, characteristic curve C
Output	
Output voltage	12 V DC
Output voltage adjustment	± 10% nominal output voltage tolerance, adjustable with potentiometer
Output current	6 A@12 V DC
Output power	75 W
Residual ripple, breaking spikes	< 100 mV _{pp}
Overload protection	120~150% lkonst. of max. output power, automatic restart
Surge protection	13.5...16.2 V @ 12 V DC
Mains failure bridge-over time	20 ms
Control at 10...100% load	0.5%
Parallel connection option	Recommended with diode module
Insulation coordination	
Electrical isolation, output-earth	0.5 kV
Electrical isolation, input-earth	1.5 kV
Electrical isolation, input-output	3 kV
General data	
Ambient temperature (operational)	-20°C...70°C (>50°C derating, refer derated curve); 70% rated load@70°C
Storage temperature	-20 °C...+85 °C
Max. perm. air humidity (operational)	5 %...95 % RH
Degree of efficiency	81 % @ 12 V DC
Status indicator	Operation, green LED
Standards	EN 60950
EMC standards	EN 55011, EN 55022, EN 55024, EN 61000-6 /-2, -3
Mounting position, installation notice	Panel mount, screw fix
Weight	440 g
Approvals	CE
Screw connection	
Connection cross-section, solid, min. / max.	0.34 / 4 mm ²
Depth x width x height	135 / 98.5 / 40 mm

Note

Ordering data

Type	Qty.	Order No.
CP E SNT 75W 5V 12A	1	1202470000

Type	Qty.	Order No.
CP E SNT 75W 12V 6A	1	1202480000

Note

The internal varistor found in a switch-mode power supply does not replace the necessary surge protection in a system.

The internal varistor found in a switch-mode power supply does not replace the necessary surge protection in a system.

Accessories

Note

connectPower
PRO-E



CP E SNT 75W 24V 3.2A

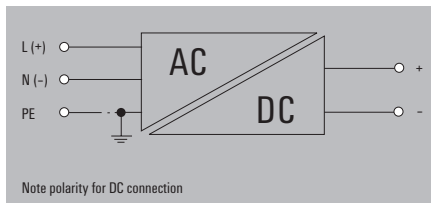

CP E SNT 75W 48V 1.6A

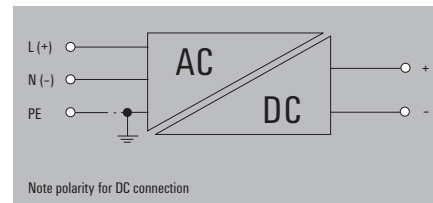

Technical data

Input	
Input voltage	85...264 V AC / 110...370 V DC
Input current	1 A @ 230 V AC / 2 A @ 120 V AC
Input frequency	47...63 Hz
Input fuse (internal)	yes / max. 20A
Recommended back-up fuse	4 A at 230 V AC, characteristic curve C
Output	
Output voltage	24 V DC
Output voltage adjustment	± 10% nominal output voltage tolerance, adjustable with potentiometer
Output current	3.2 A@24 V DC
Output power	75 W
Residual ripple, breaking spikes	< 100 mV _{pp}
Overload protection	120~150% lkonst. of max. output power, automatic restart
Surge protection	28...32 V @ 24 V DC
Mains failure bridge-over time	20 ms
Control at 10...100% load	0.5%
Parallel connection option	Recommended with diode module
Insulation coordination	
Electrical isolation, output-earth	0.5 kV
Electrical isolation, input-earth	1.5 kV
Electrical isolation, input-output	3 kV
General data	
Ambient temperature (operational)	-20°C...70°C (>50°C derating, refer derated curve); 70% rated load@70°C
Storage temperature	-20 °C...+85 °C
Max. perm. air humidity (operational)	5 %...95 % RH
Degree of efficiency	85 % @ 24 V DC
Status indicator	Operation, green LED
Standards	EN 60950
EMC standards	EN 55011, EN 55022, EN 55024, EN 61000-6 /-2, -3
Mounting position, installation notice	Panel mount, screw fix
Weight	440 g
Approvals	CE
Screw connection	
Connection cross-section, solid, min. / max.	0.34 / 4 mm ²
Depth x width x height	135 / 98.5 / 40 mm

Input	
Input voltage	85...264 V AC / 110...370 V DC
Input current	1 A @ 230 V AC / 2 A @ 120 V AC
Input frequency	47...63 Hz
Input fuse (internal)	yes / max. 20A
Recommended back-up fuse	4 A at 230 V AC, characteristic curve C
Output	
Output voltage	48 V DC
Output voltage adjustment	± 10% nominal output voltage tolerance, adjustable with potentiometer
Output current	1.6 A@48 V DC
Output power	75 W
Residual ripple, breaking spikes	< 100 mV _{pp}
Overload protection	120~150% lkonst. of max. output power, automatic restart
Surge protection	55...62 V @ 48 V DC
Mains failure bridge-over time	20 ms
Control at 10...100% load	0.5%
Parallel connection option	Recommended with diode module
Insulation coordination	
Electrical isolation, output-earth	0.5 kV
Electrical isolation, input-earth	1.5 kV
Electrical isolation, input-output	3 kV
General data	
Ambient temperature (operational)	-20°C...70°C (>50°C derating, refer derated curve); 70% rated load@70°C
Storage temperature	-20 °C...+85 °C
Max. perm. air humidity (operational)	5 %...95 % RH
Degree of efficiency	86 % @ 48 V DC
Status indicator	Operation, green LED
Standards	EN 60950
EMC standards	EN 55011, EN 55022, EN 55024, EN 61000-6 /-2, -3
Mounting position, installation notice	Panel mount, screw fix
Weight	440 g
Approvals	CE
Screw connection	
Connection cross-section, solid, min. / max.	0.34 / 4 mm ²
Depth x width x height	135 / 98.5 / 40 mm

Input	
Input voltage	85...264 V AC / 110...370 V DC
Input current	1 A @ 230 V AC / 2 A @ 120 V AC
Input frequency	47...63 Hz
Input fuse (internal)	yes / max. 20A
Recommended back-up fuse	4 A at 230 V AC, characteristic curve C
Output	
Output voltage	48 V DC
Output voltage adjustment	± 10% nominal output voltage tolerance, adjustable with potentiometer
Output current	1.6 A@48 V DC
Output power	75 W
Residual ripple, breaking spikes	< 100 mV _{pp}
Overload protection	120~150% lkonst. of max. output power, automatic restart
Surge protection	55...62 V @ 48 V DC
Mains failure bridge-over time	20 ms
Control at 10...100% load	0.5%
Parallel connection option	Recommended with diode module
Insulation coordination	
Electrical isolation, output-earth	0.5 kV
Electrical isolation, input-earth	1.5 kV
Electrical isolation, input-output	3 kV
General data	
Ambient temperature (operational)	-20°C...70°C (>50°C derating, refer derated curve); 70% rated load@70°C
Storage temperature	-20 °C...+85 °C
Max. perm. air humidity (operational)	5 %...95 % RH
Degree of efficiency	86 % @ 48 V DC
Status indicator	Operation, green LED
Standards	EN 60950
EMC standards	EN 55011, EN 55022, EN 55024, EN 61000-6 /-2, -3
Mounting position, installation notice	Panel mount, screw fix
Weight	440 g
Approvals	CE
Screw connection	
Connection cross-section, solid, min. / max.	0.34 / 4 mm ²
Depth x width x height	135 / 98.5 / 40 mm

Note

Ordering data

Type	Qty.	Order No.
CP E SNT 75W 24V 3.2A	1	1202490000

Type	Qty.	Order No.
CP E SNT 75W 24V 3.2A	1	1202490000

Type	Qty.	Order No.
CP E SNT 75W 48V 1.6A	1	1202510000

Note

The internal varistor found in a switch-mode power supply does not replace the necessary surge protection in a system.

The internal varistor found in a switch-mode power supply does not replace the necessary surge protection in a system.

Accessories

Note

connectPower PRO-E

connectPower PRO-E

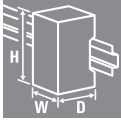

CP E SNT 100W 5V 16A



CP E SNT 100W 12V 8.5A

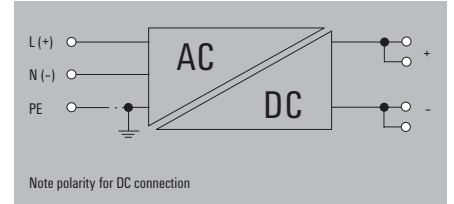
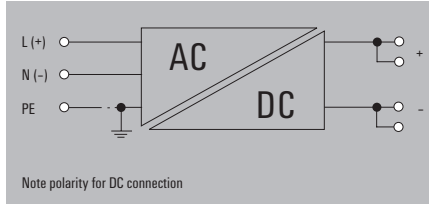

Technical data

Input	
Input voltage	88...132 V AC / 176...264 V AC optional / 250...370 V DC
Input current	1.5 A @ 230 V AC / 3 A @ 120 V AC
Input frequency	47...63 Hz
Input fuse (internal)	yes / max. 20A
Recommended back-up fuse	4 A at 230 V AC, characteristic curve C
Output	
Output voltage	5 V DC
Output voltage adjustment	± 10% nominal output voltage tolerance, adjustable with potentiometer
Output current	16 A@5 V DC
Output power	100 W
Residual ripple, breaking spikes	< 100 mV _{pp}
Overload protection	120~150% lkonst. of max. output power, automatic restart
Surge protection	5.6...6.8 V @ 5 V DC
Mains failure bridge-over time	20 ms
Control at 10...100% load	0.5%
Parallel connection option	Recommended with diode module
Insulation coordination	
Electrical isolation, output-earth	0.5 kV
Electrical isolation, input-earth	1.5 kV
Electrical isolation, input-output	3 kV
General data	
Ambient temperature (operational)	-20°C...70°C (>50°C derating, refer derated curve); 70% rated load@70°C
Storage temperature	-20 °C...+85 °C
Max. perm. air humidity (operational)	5 %...95 % RH
Degree of efficiency	77 % @ 5 V DC
Status indicator	Operation, green LED
Standards	EN 60950
EMC standards	EN 55011, EN 55022, EN 55024, EN 61000-6 /-2, -3
Mounting position, installation notice	Panel mount, screw fix
Weight	590 g
Approvals	CE
Screw connection	
Connection cross-section, solid, min. / max.	0.34 / 4 mm ²
Depth x width x height	164 / 97.5 / 40 mm

Output voltage	12 V DC
Output voltage adjustment	± 10% nominal output voltage tolerance, adjustable with potentiometer
Output current	8.5 A@12 V DC
Output power	100 W
Residual ripple, breaking spikes	< 100 mV _{pp}
Overload protection	120~150% lkonst. of max. output power, automatic restart
Surge protection	13.5...16.2 V @ 12 V DC
Mains failure bridge-over time	20 ms
Control at 10...100% load	0.5%
Parallel connection option	Recommended with diode module
Insulation coordination	
Electrical isolation, output-earth	0.5 kV
Electrical isolation, input-earth	1.5 kV
Electrical isolation, input-output	3 kV
General data	
Ambient temperature (operational)	-20°C...70°C (>50°C derating, refer derated curve); 70% rated load@70°C
Storage temperature	-20 °C...+85 °C
Max. perm. air humidity (operational)	5 %...95 % RH
Degree of efficiency	81 % @ 12 V DC
Status indicator	Operation, green LED
Standards	EN 60950
EMC standards	EN 55011, EN 55022, EN 55024, EN 61000-6 /-2, -3
Mounting position, installation notice	Panel mount, screw fix
Weight	590 g
Approvals	CE
Screw connection	
Connection cross-section, solid, min. / max.	0.34 / 4 mm ²
Depth x width x height	164 / 97.5 / 40 mm

Note	
The internal varistor found in a switch-mode power supply does not replace the necessary surge protection in a system.	

Ordering data

Type	Qty.	Order No.
CP E SNT 100W 5V 16A	1	1165820000

Type	Qty.	Order No.
CP E SNT 100W 12V 8.5A	1	1165830000

Type	Qty.	Order No.
CP E SNT 100W 12V 8.5A	1	1165830000

Note

Accessories

Note
The internal varistor found in a switch-mode power supply does not replace the necessary surge protection in a system.

The internal varistor found in a switch-mode power supply does not replace the necessary surge protection in a system.

The internal varistor found in a switch-mode power supply does not replace the necessary surge protection in a system.

connectPower
PRO-E



CP E SNT 100W 24V 4.5A

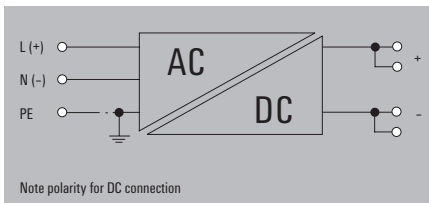

CP E SNT 100W 48V 2.3A

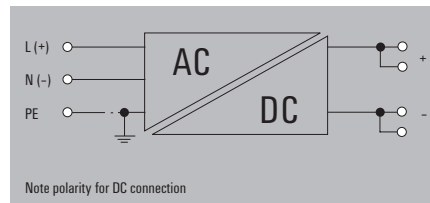

Technical data

Input	
Input voltage	88...132 V AC / 176...264 V AC optional / 250...370 V DC
Input current	1.5 A @ 230 V AC / 3 A @ 120 V AC
Input frequency	47...63 Hz
Input fuse (internal)	yes / max. 20A
Recommended back-up fuse	4 A at 230 V AC, characteristic curve C
Output	
Output voltage	24 V DC
Output voltage adjustment	± 10% nominal output voltage tolerance, adjustable with potentiometer
Output current	4.5 A@24 V DC
Output power	100 W
Residual ripple, breaking spikes	< 100 mV _{pp}
Overload protection	120~150% Ikonst. of max. output power, automatic restart
Surge protection	28...32 V @ 24 V DC
Mains failure bridge-over time	20 ms
Control at 10...100% load	0.5%
Parallel connection option	Recommended with diode module
Insulation coordination	
Electrical isolation, output-earth	0.5 kV
Electrical isolation, input-earth	1.5 kV
Electrical isolation, input-output	3 kV
General data	
Ambient temperature (operational)	-20°C...70°C (>50°C derating, refer derated curve); 70% rated load@70°C
Storage temperature	-20 °C...+85 °C
Max. perm. air humidity (operational)	5 %...95 % RH
Degree of efficiency	85 % @ 24 V DC
Status indicator	Operation, green LED
Standards	EN 60950
EMC standards	EN 55011, EN 55022, EN 55024, EN 61000-6 /-2, -3
Mounting position, installation notice	Panel mount, screw fix
Weight	590 g
Approvals	CE
Screw connection	
Connection cross-section, solid, min. / max.	0.34 / 4 mm ²
Depth x width x height	164 / 97.5 / 40 mm

Note

Ordering data

Type	Qty.	Order No.
CP E SNT 100W 24V 4.5A	1	1165840000

Note

Accessories

Note

Input	
Input voltage	88...132 V AC / 176...264 V AC optional / 250...370 V DC
Input current	1.5 A @ 230 V AC / 3 A @ 120 V AC
Input frequency	47...63 Hz
Input fuse (internal)	yes / max. 20A
Recommended back-up fuse	4 A at 230 V AC, characteristic curve C
Output	
Output voltage	48 V DC
Output voltage adjustment	± 10% nominal output voltage tolerance, adjustable with potentiometer
Output current	2.3 A@48 V DC
Output power	100 W
Residual ripple, breaking spikes	< 100 mV _{pp}
Overload protection	120~150% Ikonst. of max. output power, automatic restart
Surge protection	55...62 V @ 48 V DC
Mains failure bridge-over time	20 ms
Control at 10...100% load	0.5%
Parallel connection option	Recommended with diode module
Insulation coordination	
Electrical isolation, output-earth	0.5 kV
Electrical isolation, input-earth	1.5 kV
Electrical isolation, input-output	3 kV
General data	
Ambient temperature (operational)	-20°C...70°C (>50°C derating, refer derated curve); 70% rated load@70°C
Storage temperature	-20 °C...+85 °C
Max. perm. air humidity (operational)	5 %...95 % RH
Degree of efficiency	86 % @ 48 V DC
Status indicator	Operation, green LED
Standards	EN 60950
EMC standards	EN 55011, EN 55022, EN 55024, EN 61000-6 /-2, -3
Mounting position, installation notice	Panel mount, screw fix
Weight	590 g
Approvals	CE
Screw connection	
Connection cross-section, solid, min. / max.	0.34 / 4 mm ²
Depth x width x height	164 / 97.5 / 40 mm

Note

Type	Qty.	Order No.
CP E SNT 100W 48V 2.3A	1	1165850000

Note

Accessories

Note

Input	
Input voltage	88...132 V AC / 176...264 V AC optional / 250...370 V DC
Input current	1.5 A @ 230 V AC / 3 A @ 120 V AC
Input frequency	47...63 Hz
Input fuse (internal)	yes / max. 20A
Recommended back-up fuse	4 A at 230 V AC, characteristic curve C
Output	
Output voltage	48 V DC
Output voltage adjustment	± 10% nominal output voltage tolerance, adjustable with potentiometer
Output current	2.3 A@48 V DC
Output power	100 W
Residual ripple, breaking spikes	< 100 mV _{pp}
Overload protection	120~150% Ikonst. of max. output power, automatic restart
Surge protection	55...62 V @ 48 V DC
Mains failure bridge-over time	20 ms
Control at 10...100% load	0.5%
Parallel connection option	Recommended with diode module
Insulation coordination	
Electrical isolation, output-earth	0.5 kV
Electrical isolation, input-earth	1.5 kV
Electrical isolation, input-output	3 kV
General data	
Ambient temperature (operational)	-20°C...70°C (>50°C derating, refer derated curve); 70% rated load@70°C
Storage temperature	-20 °C...+85 °C
Max. perm. air humidity (operational)	5 %...95 % RH
Degree of efficiency	86 % @ 48 V DC
Status indicator	Operation, green LED
Standards	EN 60950
EMC standards	EN 55011, EN 55022, EN 55024, EN 61000-6 /-2, -3
Mounting position, installation notice	Panel mount, screw fix
Weight	590 g
Approvals	CE
Screw connection	
Connection cross-section, solid, min. / max.	0.34 / 4 mm ²
Depth x width x height	164 / 97.5 / 40 mm

Note

Type	Qty.	Order No.
CP E SNT 100W 48V 2.3A	1	1165850000

Note

Accessories

Note

connectPower PRO-E

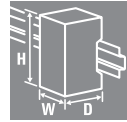

CP E SNT 150W 12V 12.5A

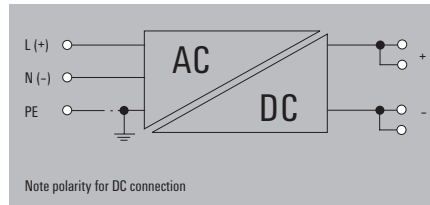

CP E SNT 150W 24V 6.5A

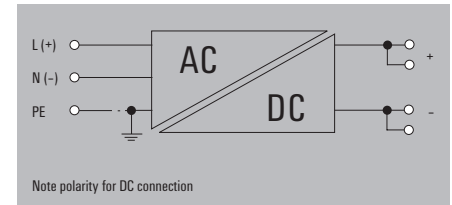

Technical data

Input	
Input voltage	88...132 V AC / 176...264 V AC optional / 250...370 V DC
Input current	2 A @ 230 V AC / 3.5 A @ 120 V AC
Input frequency	47...63 Hz
Input fuse (internal)	yes / max. 35A
Recommended back-up fuse	4 A at 230 V AC, characteristic curve C
Output	
Output voltage	12 V DC
Output voltage adjustment	± 10% nominal output voltage tolerance, adjustable with potentiometer
Output current	12.5 A@12 V DC
Output power	150 W
Residual ripple, breaking spikes	< 100 mV _{pp}
Overload protection	120~150% lkonst. of max. output power, automatic restart
Surge protection	13.5...16.2 V @ 12 V DC
Mains failure bridge-over time	20 ms
Control at 10...100% load	0.5%
Parallel connection option	Recommended with diode module
Insulation coordination	
Electrical isolation, output-earth	0.5 kV
Electrical isolation, input-earth	1.5 kV
Electrical isolation, input-output	3 kV
General data	
Ambient temperature (operational)	-20°C...70°C (>50°C derating, refer derated curve); 70% rated load@70°C
Storage temperature	-20 °C...+85 °C
Max. perm. air humidity (operational)	5 %...95 % RH
Degree of efficiency	82 % @ 12 V DC
Status indicator	Operation, green LED
Standards	EN 60950
EMC standards	EN 55011, EN 55022, EN 55024, EN 61000-6 /2, -3
Mounting position, installation notice	Panel mount, screw fix
Weight	820 g
Approvals	CE
Screw connection	
Connection cross-section, solid, min. / max.	0.34 / 4 mm ²
Depth x width x height	205 / 99 / 40 mm

Input	
Input voltage	88...132 V AC / 176...264 V AC optional / 250...370 V DC
Input current	2 A @ 230 V AC / 3.5 A @ 120 V AC
Input frequency	47...63 Hz
Input fuse (internal)	yes / max. 35A
Recommended back-up fuse	4 A at 230 V AC, characteristic curve C
Output	
Output voltage	24 V DC
Output voltage adjustment	± 10% nominal output voltage tolerance, adjustable with potentiometer
Output current	6.5 A@24 V DC
Output power	150 W
Residual ripple, breaking spikes	< 100 mV _{pp}
Overload protection	120~150% lkonst. of max. output power, automatic restart
Surge protection	28...32 V @ 24 V DC
Mains failure bridge-over time	20 ms
Control at 10...100% load	0.5%
Parallel connection option	Recommended with diode module
Insulation coordination	
Electrical isolation, output-earth	0.5 kV
Electrical isolation, input-earth	1.5 kV
Electrical isolation, input-output	3 kV
General data	
Ambient temperature (operational)	-20°C...70°C (>50°C derating, refer derated curve); 70% rated load@70°C
Storage temperature	-20 °C...+85 °C
Max. perm. air humidity (operational)	5 %...95 % RH
Degree of efficiency	86 % @ 24 V DC
Status indicator	Operation, green LED
Standards	EN 60950
EMC standards	EN 55011, EN 55022, EN 55024, EN 61000-6 /2, -3
Mounting position, installation notice	Panel mount, screw fix
Weight	820 g
Approvals	CE
Screw connection	
Connection cross-section, solid, min. / max.	0.34 / 4 mm ²
Depth x width x height	205 / 99 / 40 mm

Input	
Input voltage	88...132 V AC / 176...264 V AC optional / 250...370 V DC
Input current	2 A @ 230 V AC / 3.5 A @ 120 V AC
Input frequency	47...63 Hz
Input fuse (internal)	yes / max. 35A
Recommended back-up fuse	4 A at 230 V AC, characteristic curve C
Output	
Output voltage	24 V DC
Output voltage adjustment	± 10% nominal output voltage tolerance, adjustable with potentiometer
Output current	6.5 A@24 V DC
Output power	150 W
Residual ripple, breaking spikes	< 100 mV _{pp}
Overload protection	120~150% lkonst. of max. output power, automatic restart
Surge protection	28...32 V @ 24 V DC
Mains failure bridge-over time	20 ms
Control at 10...100% load	0.5%
Parallel connection option	Recommended with diode module
Insulation coordination	
Electrical isolation, output-earth	0.5 kV
Electrical isolation, input-earth	1.5 kV
Electrical isolation, input-output	3 kV
General data	
Ambient temperature (operational)	-20°C...70°C (>50°C derating, refer derated curve); 70% rated load@70°C
Storage temperature	-20 °C...+85 °C
Max. perm. air humidity (operational)	5 %...95 % RH
Degree of efficiency	86 % @ 24 V DC
Status indicator	Operation, green LED
Standards	EN 60950
EMC standards	EN 55011, EN 55022, EN 55024, EN 61000-6 /2, -3
Mounting position, installation notice	Panel mount, screw fix
Weight	820 g
Approvals	CE
Screw connection	
Connection cross-section, solid, min. / max.	0.34 / 4 mm ²
Depth x width x height	205 / 99 / 40 mm

Note

Ordering data

Type	Qty.	Order No.
CP E SNT 150W 12V 12.5A	1	1165870000

Type	Qty.	Order No.
CP E SNT 150W 24V 6.5A	1	1165880000

Type	Qty.	Order No.
CP E SNT 150W 24V 6.5A	1	1165880000

Note

The internal varistor found in a switch-mode power supply does not replace the necessary surge protection in a system.

The internal varistor found in a switch-mode power supply does not replace the necessary surge protection in a system.

Accessories

Note

Note

Note

**connectPower
PRO-E**

CP E SNT 150W 48V 3.3A

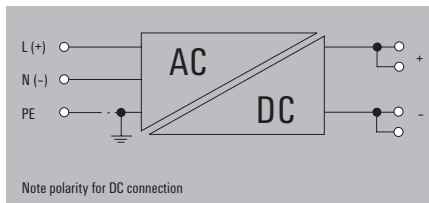

Technical data

Input	
Input voltage	88...132 V AC / 176...264 V AC optional / 250...370 V DC
Input current	2 A @ 230 V AC / 3.5 A @ 120 V AC
Input frequency	47...63 Hz
Input fuse (internal)	yes / max. 35A
Recommended back-up fuse	4 A at 230 V AC, characteristic curve C
Output	
Output voltage	48 V DC
Output voltage adjustment	± 10% nominal output voltage tolerance, adjustable with potentiometer
Output current	3.3 A@48 V DC
Output power	150 W
Residual ripple, breaking spikes	< 100 mV _{pp}
Overload protection	120~150% Ikonst. of max. output power, automatic restart
Surge protection	55...62 V @ 48 V DC
Mains failure bridge-over time	20 ms
Control at 10...100% load	0.5%
Parallel connection option	Recommended with diode module
Insulation coordination	
Electrical isolation, output-earth	0.5 kV
Electrical isolation, input-earth	1.5 kV
Electrical isolation, input-output	3 kV
General data	
Ambient temperature (operational)	-20°C...70°C (>50°C derating, refer derated curve); 70% rated load@70°C
Storage temperature	-20 °C...+85 °C
Max. perm. air humidity (operational)	5 %...95 % RH
Degree of efficiency	87 % @ 48 V DC
Status indicator	Operation, green LED
Standards	EN 60950
EMC standards	EN 55011, EN 55022, EN 55024, EN 61000-6 /2, -3
Mounting position, installation notice	Panel mount, screw fix
Weight	820 g
Approvals	CE
Screw connection	
Connection cross-section, solid, min. / max.	0.34 / 4 mm ²
Depth x width x height	205 / 99 / 40 mm

Input		
Input voltage	88...132 V AC / 176...264 V AC optional / 250...370 V DC	
Input current	2 A @ 230 V AC / 3.5 A @ 120 V AC	
Input frequency	47...63 Hz	
Input fuse (internal)	yes / max. 35A	
Recommended back-up fuse	4 A at 230 V AC, characteristic curve C	
Output		
Output voltage	48 V DC	
Output voltage adjustment	± 10% nominal output voltage tolerance, adjustable with potentiometer	
Output current	3.3 A@48 V DC	
Output power	150 W	
Residual ripple, breaking spikes	< 100 mV _{pp}	
Overload protection	120~150% Ikonst. of max. output power, automatic restart	
Surge protection	55...62 V @ 48 V DC	
Mains failure bridge-over time	20 ms	
Control at 10...100% load	0.5%	
Parallel connection option	Recommended with diode module	
Insulation coordination		
Electrical isolation, output-earth	0.5 kV	
Electrical isolation, input-earth	1.5 kV	
Electrical isolation, input-output	3 kV	
General data		
Ambient temperature (operational)	-20°C...70°C (>50°C derating, refer derated curve); 70% rated load@70°C	
Storage temperature	-20 °C...+85 °C	
Max. perm. air humidity (operational)	5 %...95 % RH	
Degree of efficiency	87 % @ 48 V DC	
Status indicator	Operation, green LED	
Standards	EN 60950	
EMC standards	EN 55011, EN 55022, EN 55024, EN 61000-6 /2, -3	
Mounting position, installation notice	Panel mount, screw fix	
Weight	820 g	
Approvals	CE	
Screw connection		
Connection cross-section, solid, min. / max.	0.34 / 4 mm ²	
Depth x width x height	205 / 99 / 40 mm	

Note

Ordering data

Type	Qty.	Order No.
CP E SNT 150W 48V 3.3A	1	1165890000

Note

The internal varistor found in a switch-mode power supply does not replace the necessary surge protection in a system.

Accessories

Note

connectPower PRO-E

connectPower PRO-E

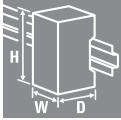

CP E SNT 250W 12V 21A

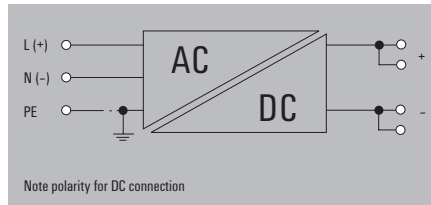

CP E SNT 250W 24V 10.5A

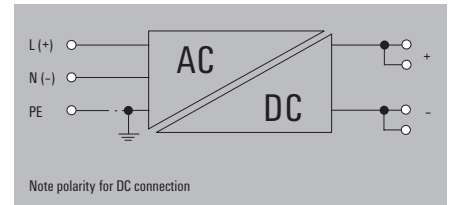

Technical data

Input	
Input voltage	88...132 V AC / 176...264 V AC optional / 250...370 V DC
Input current	2.5 A @ 230 V AC / 4.7 A @ 120 V AC
Input frequency	47...63 Hz
Input fuse (internal)	yes / max. 35A
Recommended back-up fuse	6 A at 230 V AC, characteristic curve C
Output	
Output voltage	12 V DC
Output voltage adjustment	± 10% nominal output voltage tolerance, adjustable with potentiometer
Output current	21 A @ 12 V DC
Output power	250 W
Residual ripple, breaking spikes	< 100 mV _{pp}
Overload protection	120~150% Ikonst. of max. output power, automatic restart
Surge protection	13.5...16.2 V @ 12 V DC
Mains failure bridge-over time	20 ms
Control at 10...100% load	0.5%
Parallel connection option	Recommended with diode module
Insulation coordination	
Electrical isolation, output-earth	0.5 kV
Electrical isolation, input-earth	1.5 kV
Electrical isolation, input-output	3 kV
General data	
Ambient temperature (operational)	-20°C...70°C (>50°C derating, refer derated curve); 70% rated load@70°C
Storage temperature	-20 °C...+85 °C
Max. perm. air humidity (operational)	5 %...95 % RH
Degree of efficiency	80 % @ 12 V DC
Status indicator	Operation, green LED
Standards	EN 60950
EMC standards	EN 55011, EN 55022, EN 55024, EN 61000-6 /-2, -3
Mounting position, installation notice	Panel mount, screw fix
Weight	1080 g
Approvals	CE
Screw connection	
Connection cross-section, solid, min. / max.	0.34 / 4 mm ²
Depth x width x height	231 / 115 / 49.5 mm

Input		
Input voltage	88...132 V AC / 176...264 V AC optional / 250...370 V DC	
Input current	2.5 A @ 230 V AC / 4.7 A @ 120 V AC	
Input frequency	47...63 Hz	
Input fuse (internal)	yes / max. 35A	
Recommended back-up fuse	6 A at 230 V AC, characteristic curve C	
Output		
Output voltage	12 V DC	
Output voltage adjustment	± 10% nominal output voltage tolerance, adjustable with potentiometer	
Output current	21 A @ 12 V DC	
Output power	250 W	
Residual ripple, breaking spikes	< 100 mV _{pp}	
Overload protection	120~150% Ikonst. of max. output power, automatic restart	
Surge protection	13.5...16.2 V @ 12 V DC	
Mains failure bridge-over time	20 ms	
Control at 10...100% load	0.5%	
Parallel connection option	Recommended with diode module	
Insulation coordination		
Electrical isolation, output-earth	0.5 kV	
Electrical isolation, input-earth	1.5 kV	
Electrical isolation, input-output	3 kV	
General data		
Ambient temperature (operational)	-20°C...70°C (>50°C derating, refer derated curve); 70% rated load@70°C	
Storage temperature	-20 °C...+85 °C	
Max. perm. air humidity (operational)	5 %...95 % RH	
Degree of efficiency	80 % @ 12 V DC	
Status indicator	Operation, green LED	
Standards	EN 60950	
EMC standards	EN 55011, EN 55022, EN 55024, EN 61000-6 /-2, -3	
Mounting position, installation notice	Panel mount, screw fix	
Weight	1080 g	
Approvals	CE	
Screw connection		
Connection cross-section, solid, min. / max.	0.34 / 4 mm ²	
Depth x width x height	231 / 115 / 49.5 mm	

Input		
Input voltage	88...132 V AC / 176...264 V AC optional / 250...370 V DC	
Input current	2.5 A @ 230 V AC / 4.7 A @ 120 V AC	
Input frequency	47...63 Hz	
Input fuse (internal)	yes / max. 35A	
Recommended back-up fuse	6 A at 230 V AC, characteristic curve C	
Output		
Output voltage	24 V DC	
Output voltage adjustment	± 10% nominal output voltage tolerance, adjustable with potentiometer	
Output current	10.5 A @ 24 V DC	
Output power	250 W	
Residual ripple, breaking spikes	< 100 mV _{pp}	
Overload protection	120~150% Ikonst. of max. output power, automatic restart	
Surge protection	28...32 V @ 24 V DC	
Mains failure bridge-over time	20 ms	
Control at 10...100% load	0.5%	
Parallel connection option	Recommended with diode module	
Insulation coordination		
Electrical isolation, output-earth	0.5 kV	
Electrical isolation, input-earth	1.5 kV	
Electrical isolation, input-output	3 kV	
General data		
Ambient temperature (operational)	-20°C...70°C (>50°C derating, refer derated curve); 70% rated load@70°C	
Storage temperature	-20 °C...+85 °C	
Max. perm. air humidity (operational)	5 %...95 % RH	
Degree of efficiency	81 % @ 24 V DC	
Status indicator	Operation, green LED	
Standards	EN 60950	
EMC standards	EN 55011, EN 55022, EN 55024, EN 61000-6 /-2, -3	
Mounting position, installation notice	Panel mount, screw fix	
Weight	1080 g	
Approvals	CE	
Screw connection		
Connection cross-section, solid, min. / max.	0.34 / 4 mm ²	
Depth x width x height	231 / 115 / 49.5 mm	

Note

Ordering data

Type	Qty.	Order No.
CP E SNT 250W 12V 21A	1	1202520000

Type	Qty.	Order No.
CP E SNT 250W 24V 10.5A	1	1202530000

Type	Qty.	Order No.
CP E SNT 250W 24V 10.5A	1	1202530000

Note

The internal varistor found in a switch-mode power supply does not replace the necessary surge protection in a system.

The internal varistor found in a switch-mode power supply does not replace the necessary surge protection in a system.

Accessories

Note

**connectPower
PRO-E**

CP E SNT 250W 48V 5.2A

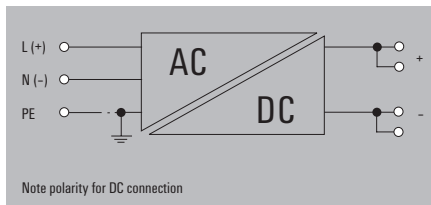

Technical data

Input	
Input voltage	88...132 V AC / 176...264 V AC optional / 250...370 V DC
Input current	2.5 A @ 230 V AC / 4.7 A @ 120 V AC
Input frequency	47...63 Hz
Input fuse (internal)	yes / max. 35A
Recommended back-up fuse	6 A at 230 V AC, characteristic curve C
Output	
Output voltage	48 V DC
Output voltage adjustment	± 10% nominal output voltage tolerance, adjustable with potentiometer
Output current	5.2 A@48 V DC
Output power	250 W
Residual ripple, breaking spikes	< 100 mV _{pp}
Overload protection	120~150% Ikonst. of max. output power, automatic restart
Surge protection	55...62 V @ 48 V DC
Mains failure bridge-over time	20 ms
Control at 10...100% load	0.5%
Parallel connection option	Recommended with diode module
Insulation coordination	
Electrical isolation, output-earth	0.5 kV
Electrical isolation, input-earth	1.5 kV
Electrical isolation, input-output	3 kV
General data	
Ambient temperature (operational)	-20°C...70°C (>50°C derating, refer derated curve); 70% rated load@70°C
Storage temperature	-20 °C...+85 °C
Max. perm. air humidity (operational)	5 %...95 % RH
Degree of efficiency	83 % @ 48 V DC
Status indicator	Operation, green LED
Standards	EN 60950
EMC standards	EN 55011, EN 55022, EN 55024, EN 61000-6 /2, -3
Mounting position, installation notice	Panel mount, screw fix
Weight	1080 g
Approvals	CE
Screw connection	
Connection cross-section, solid, min. / max.	0.34 / 4 mm ²
Depth x width x height	231 / 115 / 49.5 mm

Input		
Input voltage	88...132 V AC / 176...264 V AC optional / 250...370 V DC	
Input current	2.5 A @ 230 V AC / 4.7 A @ 120 V AC	
Input frequency	47...63 Hz	
Input fuse (internal)	yes / max. 35A	
Recommended back-up fuse	6 A at 230 V AC, characteristic curve C	
Output		
Output voltage	48 V DC	
Output voltage adjustment	± 10% nominal output voltage tolerance, adjustable with potentiometer	
Output current	5.2 A@48 V DC	
Output power	250 W	
Residual ripple, breaking spikes	< 100 mV _{pp}	
Overload protection	120~150% Ikonst. of max. output power, automatic restart	
Surge protection	55...62 V @ 48 V DC	
Mains failure bridge-over time	20 ms	
Control at 10...100% load	0.5%	
Parallel connection option	Recommended with diode module	
Insulation coordination		
Electrical isolation, output-earth	0.5 kV	
Electrical isolation, input-earth	1.5 kV	
Electrical isolation, input-output	3 kV	
General data		
Ambient temperature (operational)	-20°C...70°C (>50°C derating, refer derated curve); 70% rated load@70°C	
Storage temperature	-20 °C...+85 °C	
Max. perm. air humidity (operational)	5 %...95 % RH	
Degree of efficiency	83 % @ 48 V DC	
Status indicator	Operation, green LED	
Standards	EN 60950	
EMC standards	EN 55011, EN 55022, EN 55024, EN 61000-6 /2, -3	
Mounting position, installation notice	Panel mount, screw fix	
Weight	1080 g	
Approvals	CE	
Screw connection		
Connection cross-section, solid, min. / max.	0.34 / 4 mm ²	
Depth x width x height	231 / 115 / 49.5 mm	

Note

Ordering data

Type	Qty.	Order No.
CP E SNT 250W 48V 5.2A	1	1202540000

Note

The internal varistor found in a switch-mode power supply does not replace the necessary surge protection in a system.

Accessories

Note

connectPower PRO-E

connectPower PRO-E

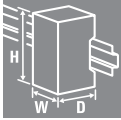

CP E SNT 350W 24V 14.6A

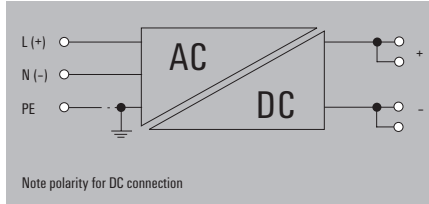

CP E SNT 350W 48V 7.3A

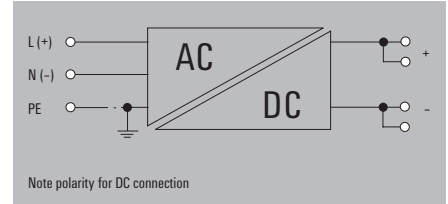

Technical data

Input	
Input voltage	85...264 V AC / 110...370 V DC
Input current	3 A @ 230 V AC / 5.6 A @ 120 V AC
Input frequency	47...63 Hz
Input fuse (internal)	yes / max. 35A
Recommended back-up fuse	6 A at 230 V AC, characteristic curve C
Output	
Output voltage	24 V DC
Output voltage adjustment	± 10% nominal output voltage tolerance, adjustable with potentiometer
Output current	14.6 A@24 V DC
Output power	350 W
Residual ripple, breaking spikes	120~150% Ikonst. of max. output power, automatic restart
Overload protection	28...32 V @ 24 V DC
Surge protection	20 ms
Mains failure bridge-over time	0.5%
Control at 10...100% load	Recommended with diode module
Parallel connection option	
Insulation coordination	
Electrical isolation, output-earth	0.5 kV
Electrical isolation, input-earth	1.5 kV
Electrical isolation, input-output	3 kV
General data	
Ambient temperature (operational)	-20°C...70°C (>50°C derating, refer derated curve); 70% rated load@70°C
Storage temperature	-20 °C...+85 °C
Max. perm. air humidity (operational)	5 %...95 % RH
Degree of efficiency	83 % @ 24 V DC
Status indicator	Operation, green LED
Standards	EN 60950
EMC standards	EN 55011, EN 55022, EN 55024, EN 61000-6 /-2, -3
Mounting position, installation notice	Panel mount, screw fix
Weight	1250 g
Approvals	CE
Screw connection	
Connection cross-section, solid, min. / max.	0.34 / 4 mm ²
Depth x width x height	230 / 115 / 49.5 mm

Output voltage	48 V DC
Output voltage adjustment	± 10% nominal output voltage tolerance, adjustable with potentiometer
Output current	7.3 A@48 V DC
Output power	350 W
Residual ripple, breaking spikes	120~150% Ikonst. of max. output power, automatic restart
Overload protection	55...62 V @ 48 V DC
Surge protection	20 ms
Mains failure bridge-over time	0.5%
Control at 10...100% load	Recommended with diode module
Parallel connection option	
Insulation coordination	
Electrical isolation, output-earth	0.5 kV
Electrical isolation, input-earth	1.5 kV
Electrical isolation, input-output	3 kV
General data	
Ambient temperature (operational)	-20°C...70°C (>50°C derating, refer derated curve); 70% rated load@70°C
Storage temperature	-20 °C...+85 °C
Max. perm. air humidity (operational)	5 %...95 % RH
Degree of efficiency	85 % @ 48 V DC
Status indicator	Operation, green LED
Standards	EN 60950
EMC standards	EN 55011, EN 55022, EN 55024, EN 61000-6 /-2, -3
Mounting position, installation notice	Panel mount, screw fix
Weight	1250 g
Approvals	CE
Screw connection	
Connection cross-section, solid, min. / max.	0.34 / 4 mm ²
Depth x width x height	230 / 115 / 49.5 mm

Note	
The internal varistor found in a switch-mode power supply does not replace the necessary surge protection in a system.	

Ordering data

Type	Qty.	Order No.
CP E SNT 350W 24V 14.6A	1	1202550000

Type	Qty.	Order No.
CP E SNT 350W 48V 7.3A	1	1202560000

Type	Qty.	Order No.
CP E SNT 350W 48V 7.3A	1	1202560000

Note

The internal varistor found in a switch-mode power supply does not replace the necessary surge protection in a system.

The internal varistor found in a switch-mode power supply does not replace the necessary surge protection in a system.

The internal varistor found in a switch-mode power supply does not replace the necessary surge protection in a system.

Accessories

Note

Note

Note

Installation drawing

CP E SNT 25W

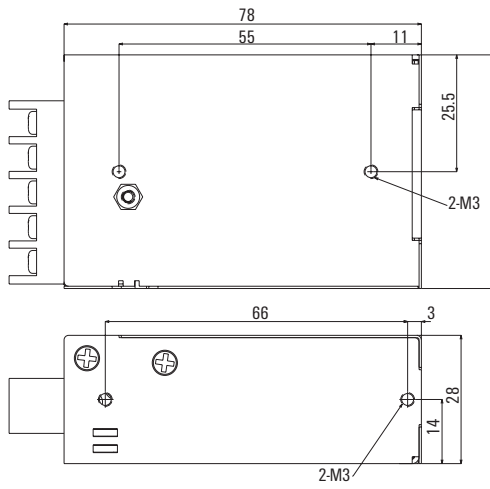

CP E SNT 50W

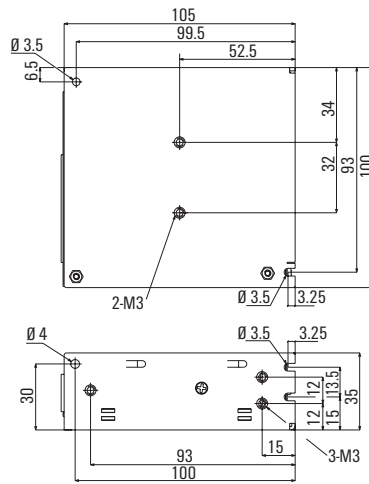

CP E SNT 75W

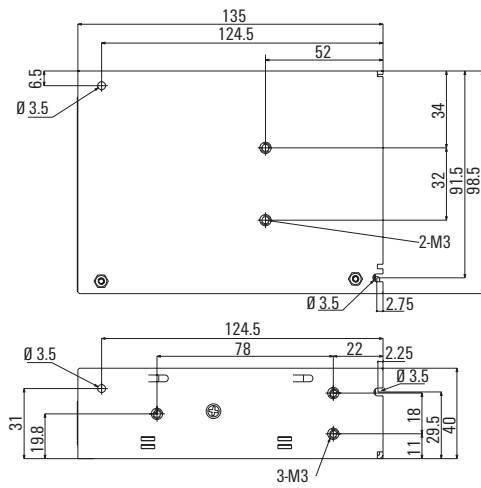

CP E SNT 100W

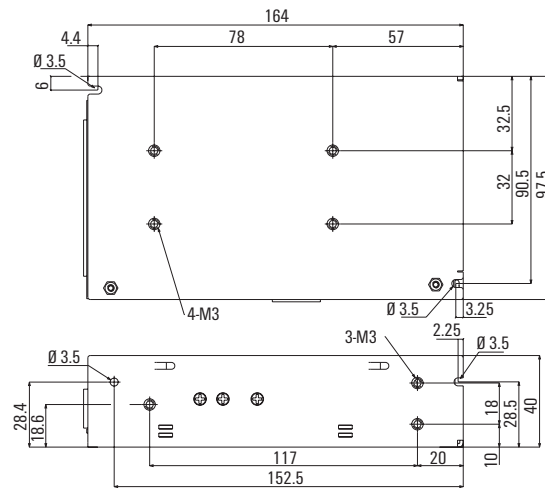

CP E SNT 150W

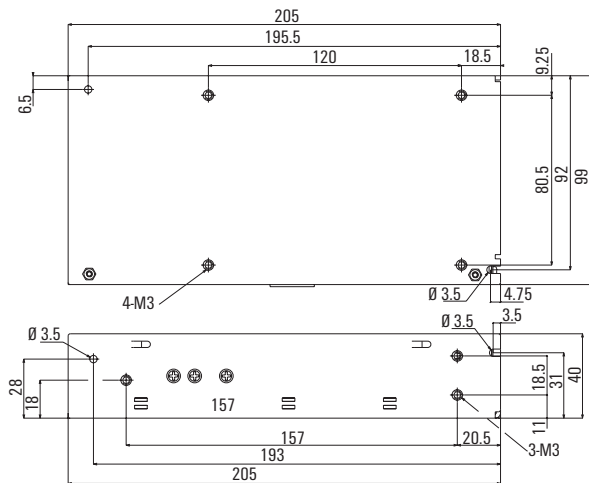

Installation drawing

CP E SNT 250W and CP E SNT 350W

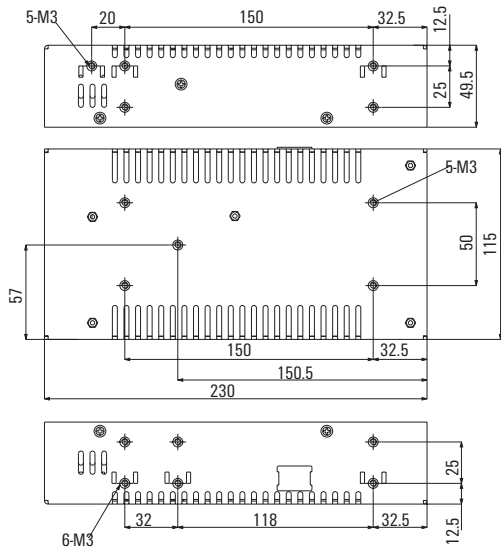

CP E SNT 250W and CP E SNT 350W (with mounting clip)

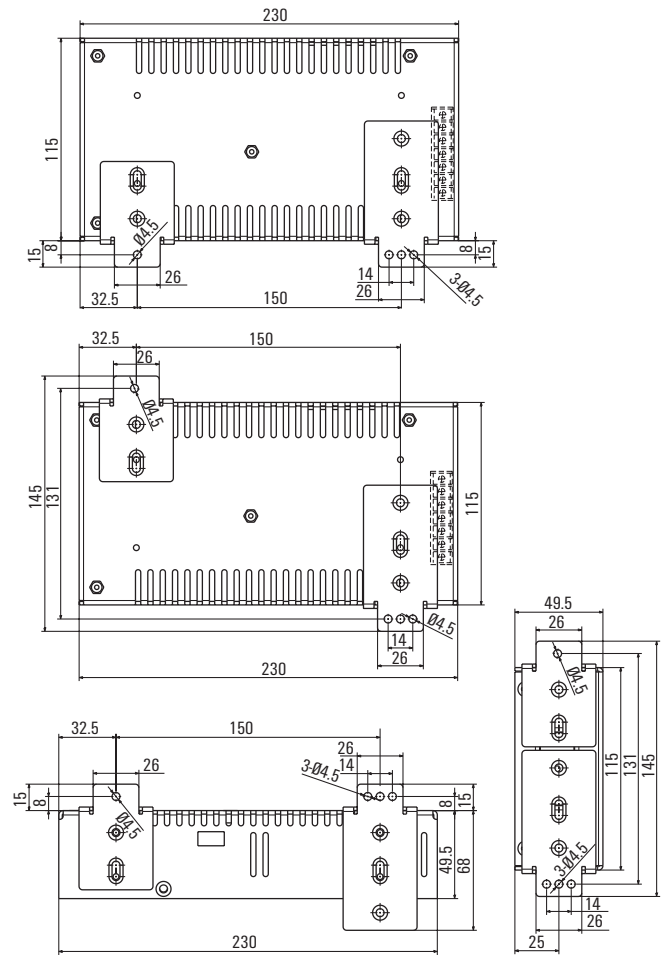

CP-E-SNT derating curve / ambient temperature

CP E SNT 25W up to CP E SNT 350W

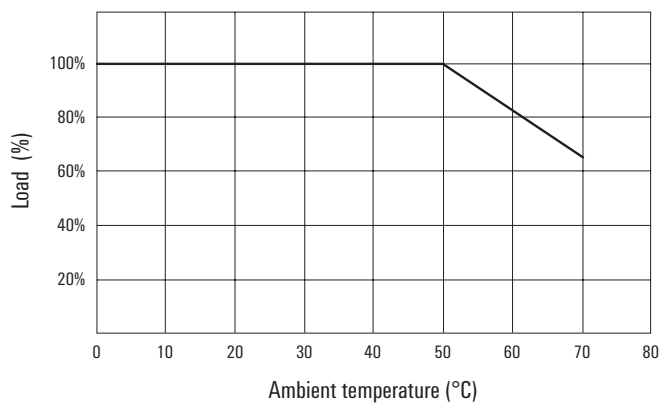

connectPower
Single-phase

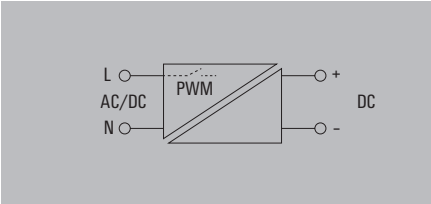
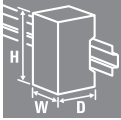

Technical data

Input	
Input voltage	85...265 V AC, 120...300 V DC
Input current	460 mA @ 115 V AC; 250 mA @ 230 V AC
Input frequency	50/ 60 Hz
Turn-on current limit	Thermistor
Input fuse	2 A time-lag fuse (internal)
Surge protection	Varistor
Output	
Output voltage	28 V DC
Output current	1 A
Output power	28 W
Max. residual ripple	< 2 %
Overload protection	Surge current / thermal cut-out
Surge protection	Varistor
Mains failure bridge-over time	35 ms @ 115 V AC / 160 ms @ 230 V AC
Control at 10...100% load	0.5%
Max. capacitance at output	8000 µF
Insulation coordination (EN 50178)	
Electrical isolation, output-earth	0.5 kV
Electrical isolation, input-earth	1.5 kV
Electrical isolation, input-output	3 kV
Electrical isolation, I/O rail	4 kV
General data	
Ambient temperature (operational)	-20 °C...+50 °C
Storage temperature	-40 °C...+85 °C
Degree of efficiency at max. load	78%
Standards	DIN EN 50178, DIN EN 60950, IEC950
Approvals	CE, CSA; cULus; GOSTME25
EMC standards	EN 61000-6 /2, -3
Parallel connection option	yes, max 2.

Dimensions	
Clamping range (nominal / min. / max.)	mm ²
Depth x width x height	mm
Note	

Ordering data

Screw connection

Note

Accessories

Note

CP SNT 24W 28V 1A

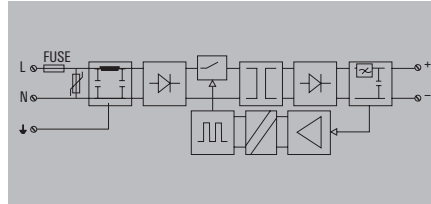

Input voltage	85...265 V AC, 120...300 V DC
Input current	460 mA @ 115 V AC; 250 mA @ 230 V AC
Input frequency	50/ 60 Hz
Turn-on current limit	Thermistor
Input fuse	2 A time-lag fuse (internal)
Surge protection	Varistor
Output	
Output voltage	28 V DC
Output current	1 A
Output power	28 W
Max. residual ripple	< 2 %
Overload protection	Surge current / thermal cut-out
Surge protection	Varistor
Mains failure bridge-over time	35 ms @ 115 V AC / 160 ms @ 230 V AC
Control at 10...100% load	0.5%
Max. capacitance at output	8000 µF
Insulation coordination (EN 50178)	
Electrical isolation, output-earth	0.5 kV
Electrical isolation, input-earth	1.5 kV
Electrical isolation, input-output	3 kV
Electrical isolation, I/O rail	4 kV
General data	
Ambient temperature (operational)	-20 °C...+50 °C
Storage temperature	-40 °C...+85 °C
Degree of efficiency at max. load	78%
Standards	DIN EN 50178, DIN EN 60950, IEC950
Approvals	CE, CSA; cULus; GOSTME25
EMC standards	EN 61000-6 /2, -3
Parallel connection option	yes, max 2.

Input/Output	
4 / 0.08 / 4	
62.5 / 52 / 90.5	
Note	
Derating loss: 33 % @ 60 °C The internal varistor found in a switch-mode power supply does not replace the need for surge protection within a system.	

Type	Qty.	Order No.
CP SNT 24W 28V 1A	1	9928890028

The internal varistor found in a switch-mode power supply does not replace the necessary surge protection in a system.

CP SNT 24W 24V 1A

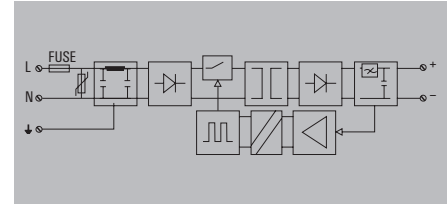

Input voltage	85...265 V AC, 120...300 V DC
Input current	460 mA @ 115 V AC; 250 mA @ 230 V AC
Input frequency	50/ 60 Hz
Turn-on current limit	Thermistor
Input fuse	2 A time-lag fuse (internal)
Surge protection	Varistor
Output	
Output voltage	24 V DC
Output current	1 A
Output power	24 W
Max. residual ripple	< 2 %
Overload protection	Surge current / thermal cut-out
Surge protection	Varistor
Mains failure bridge-over time	35 ms @ 115 V AC / 160 ms @ 230 V AC
Control at 10...100% load	0.5%
Max. capacitance at output	8000 µF
Insulation coordination (EN 50178)	
Electrical isolation, output-earth	0.5 kV
Electrical isolation, input-earth	1.5 kV
Electrical isolation, input-output	3 kV
Electrical isolation, I/O rail	4 kV
General data	
Ambient temperature (operational)	-20 °C...+50 °C
Storage temperature	-40 °C...+85 °C
Degree of efficiency at max. load	78%
Standards	DIN EN 50178, DIN EN 60950, IEC950
Approvals	CE, CSA; CSAEX; cULus; GOSTME25
EMC standards	EN 61000-6 /2, -3
Parallel connection option	yes, max 2.

Input/Output	
4 / 0.08 / 4	
62.5 / 52 / 90.5	
Note	
Derating loss: 33 % @ 60 °C The internal varistor found in a switch-mode power supply does not replace the need for surge protection within a system.	

Type	Qty.	Order No.
CP SNT 24W 24V 1A	1	9928890024

The internal varistor found in a switch-mode power supply does not replace the necessary surge protection in a system.

connectPower
Single-phase

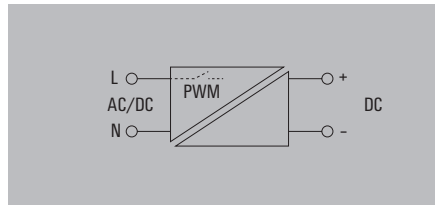
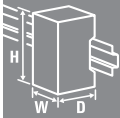

CP SNT 24W 15V 1.5A

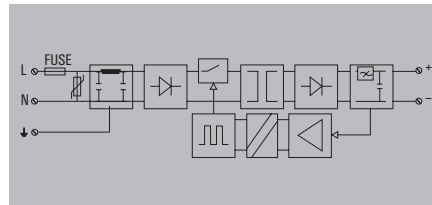

CP SNT 24W 12V 1.5A

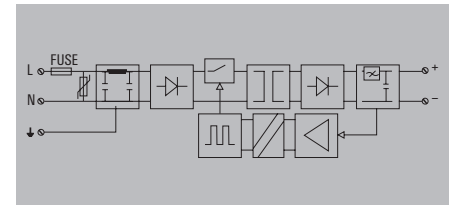

Technical data

Input	
Input voltage	85...265 V AC, 120...300 V DC
Input current	460 mA @ 115 V AC; 250 mA @ 230 V AC
Input frequency	50/ 60 Hz
Turn-on current limit	Thermistor
Input fuse	2 A time-lag fuse (internal)
Surge protection	Varistor
Output	
Output voltage	15 V DC
Output current	1.5 A
Output power	22.5 W
Max. residual ripple	< 2 %
Overload protection	Surge current / thermal cut-out
Surge protection	Varistor
Mains failure bridge-over time	35 ms @ 115 V AC / 160 ms @ 230 V AC
Control at 10...100% load	0.5%
Max. capacitance at output	8000 µF
Insulation coordination (EN 50178)	
Electrical isolation, output-earth	0.5 kV
Electrical isolation, input-earth	1.5 kV
Electrical isolation, input-output	3 kV
Electrical isolation, I/O rail	4 kV
General data	
Ambient temperature (operational)	-20 °C...+50 °C
Storage temperature	-40 °C...+85 °C
Degree of efficiency at max. load	78%
Standards	DIN EN 50178, DIN EN 60950, IEC950
Approvals	CE, CSA, cULus, GOSTME25
EMC standards	EN 61000-6 /2, -3
Parallel connection option	yes, max 2.
Dimensions	
Clamping range (nominal / min. / max.)	4 / 0.08 / 4 mm ²
Depth x width x height	62.5 / 52 / 90.5 mm
Note	
Derating loss: 33 % @ 60 °C The internal varistor found in a switch-mode power supply does not replace the need for surge protection within a system.	

Input/Output		
Type	Qty.	Order No.
CP SNT 24W 15V 1.5A	1	9928890015
Note		
The internal varistor found in a switch-mode power supply does not replace the necessary surge protection in a system.		

Input/Output		
Type	Qty.	Order No.
CP SNT 24W 12V 1.5A	1	9928890012
Note		
The internal varistor found in a switch-mode power supply does not replace the necessary surge protection in a system.		

Ordering data

Screw connection

Note

Accessories

Note

connectPower INSTAPOW

connectPower
Single-phase

CP SNT 24W 5V 2A

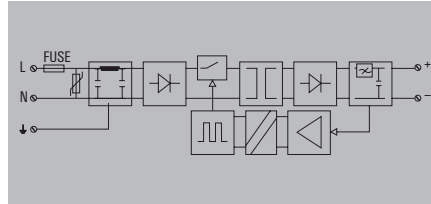
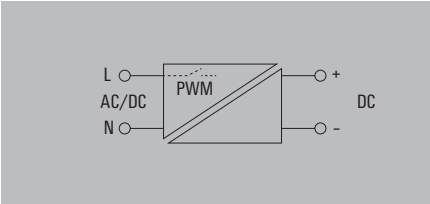
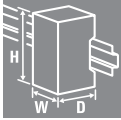

Technical data

Input	
Input voltage	85...265 V AC, 120...300 V DC
Input current	460 mA @ 115 V AC; 250 mA @ 230 V AC
Input frequency	50/ 60 Hz
Turn-on current limit	Thermistor
Input fuse	2 A time-lag fuse (internal)
Surge protection	Varistor
Output	
Output voltage	5 V DC
Output current	2 A
Output power	10 W
Max. residual ripple	< 2 %
Overload protection	Surge current / thermal cut-out
Surge protection	Varistor
Mains failure bridge-over time	35 ms @ 115 V AC / 160 ms @ 230 V AC
Control at 10...100% load	0.5%
Max. capacitance at output	8000 µF
Insulation coordination (EN 50178)	
Electrical isolation, output-earth	0.5 kV
Electrical isolation, input-earth	1.5 kV
Electrical isolation, input-output	3 kV
Electrical isolation, I/O rail	4 kV
General data	
Ambient temperature (operational)	-20 °C...+50 °C
Storage temperature	-40 °C...+85 °C
Degree of efficiency at max. load	78%
Standards	DIN EN 50178, DIN EN 60950, IEC950
Approvals	CE: CSA; cULus; GOSTME25
EMC standards	EN 61000-6 /2, -3
Parallel connection option	yes, max 2.

Input/Output		
Clamping range (nominal / min. / max.)	mm ²	4 / 0.08 / 4
Depth x width x height	mm	62.5 / 52 / 90.5
Note		
Derating loss: 33 % @ 60 °C The internal varistor found in a switch-mode power supply does not replace the need for surge protection within a system.		

Dimensions		
Clamping range (nominal / min. / max.)	mm ²	4 / 0.08 / 4
Depth x width x height	mm	62.5 / 52 / 90.5
Note		
Derating loss: 33 % @ 60 °C The internal varistor found in a switch-mode power supply does not replace the need for surge protection within a system.		

Input/Output		
Clamping range (nominal / min. / max.)	mm ²	4 / 0.08 / 4
Depth x width x height	mm	62.5 / 52 / 90.5
Note		
Derating loss: 33 % @ 60 °C The internal varistor found in a switch-mode power supply does not replace the need for surge protection within a system.		

Ordering data

Screw connection	
------------------	--

Type	Qty.	Order No.
CP SNT 24W 5V 2A	1	9928890005

Note	
The internal varistor found in a switch-mode power supply does not replace the necessary surge protection in a system.	

Accessories

Note	
-------------	--

connectPower
Single-phase

CP SNT 25W 5V 5A

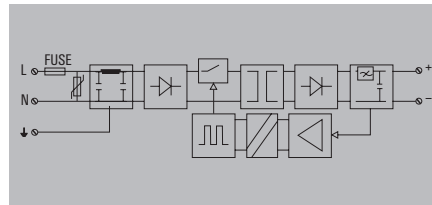
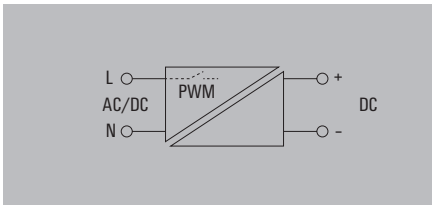
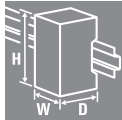

Technical data

Input

Input voltage
Input current
Input frequency
Turn-on current limit
Input fuse

85...264 V AC / 110...370 V DC
500 mA at rated load @ 230 V AC
50/ 60 Hz
Yes
Fuse link 2.5 A (T) / 250 V

Output

Output voltage
Output current
Output power
Max. residual ripple
Overload protection

4...8 V DC (adjustable via potentiometer)
5 A
25 W
120 mV_{SS}
105 %...150 % I_{load} of max. output load; automatic reset

Surge protection
Mains failure bridge-over time
Control at 10...100% load
Max. capacitance at output

Varistor
11 ms @ 115 V AC / 50 ms @ 230 V AC
1%
10000 µF

Insulation coordination (EN 50178)

Electrical isolation, output-earth
Electrical isolation, input-earth
Electrical isolation, input-output
Electrical isolation, I/O rail

0.5 kV
1.5 kV
3 kV
4 kV

General data

Ambient temperature (operational)
Storage temperature
Degree of efficiency at max. load
Standards
Approvals
EMC standards
Parallel connection option

-10...+70 °C (Derating ab 55 °C)
-20 °C...+85 °C
70%
DIN EN 50178 (PELV), DIN EN 60950 (SELV)
cCSAus; cURus; GOSTME25; UL
EN 55011, EN 55022, EN 61000-3-2,-3, EN 61000-6-2,-3,-4
Max. 3 devices (rated voltages are to be calibrated at ±20 mV)

Dimensions

Clamping range (nominal / min. / max.) mm²
Depth x width x height mm

Input/Output

2.5 / 0.5 / 4
62.5 / 70 / 90.5

Note

Ordering data

Screw connection

Type	Qty.	Order No.
CP SNT 25W 5V 5A	1	8754960000

Note

The internal varistor found in a switch-mode power supply does not replace the necessary surge protection in a system.

Accessories

Note

Derating curve

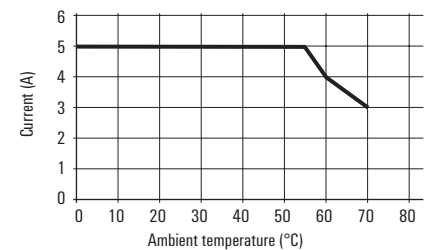

connectPower INSTAPOWERR

connectPower
Single-phase

CP SNT 48W 12V 4A

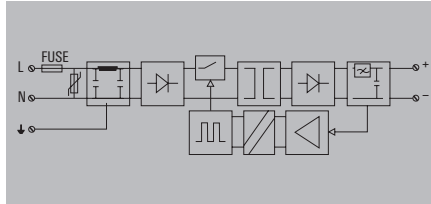
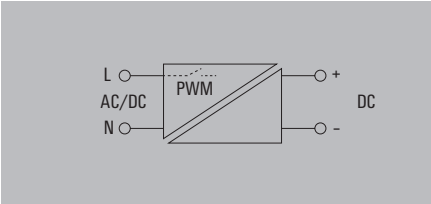
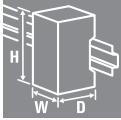

Technical data

Input

- Input voltage
- Input current
- Input frequency
- Turn-on current limit
- Input fuse

- 85...264 V AC / 110...370 V DC
- 500 mA at rated load @ 230 V AC
- 50/ 60 Hz
- Yes
- Fuse link 2.5 A (T) / 250 V

Output

- Output voltage
- Output current
- Output power
- Max. residual ripple
- Overload protection

- 9...15 V DC (adjustable via potentiometer)
- 4 A
- 48 W
- 120 mV_{SS}
- 105 %...150 % I_{load} of max. output load; automatic reset

- Surge protection
- Mains failure bridge-over time
- Control at 10...100% load
- Max. capacitance at output

- Varistor
- 11 ms @ 115 V AC / 50 ms @ 230 V AC
- 1%
- 10000 µF

Insulation coordination (EN 50178)

- Electrical isolation, output-earth
- Electrical isolation, input-earth
- Electrical isolation, input-output
- Electrical isolation, I/O rail

- 0.5 kV
- 1.5 kV
- 3 kV
- 4 kV

General data

- Ambient temperature (operational)
- Storage temperature
- Degree of efficiency at max. load
- Standards
- Approvals
- EMC standards
- Parallel connection option

- 10...+70 °C (Derating ab 55 °C)
- 20 °C...+85 °C
- 75%
- DIN EN 50178 (PELV), DIN EN 60950 (SELV)
- cCSAus; CE; cURus; GOSTME25; UL
- EN 55011, EN 55022, EN 61000-3-2,-3, EN 61000-6-2,-3,-4
- Max. 3 devices (rated voltages are to be calibrated at ±20 mV)

Derating curve

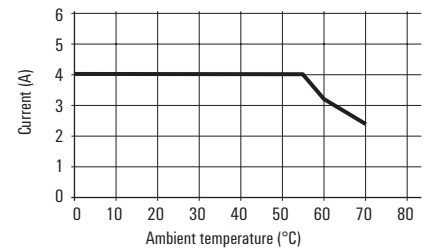

Dimensions

- Clamping range (nominal / min. / max.) mm²
- Depth x width x height mm

Input/Output

- 2.5 / 0.5 / 4
- 62.5 / 70 / 90.5

Note

Ordering data

Screw connection

Type	Qty.	Order No.
CP SNT 48W 12V 4A	1	8754970000

Note

The internal varistor found in a switch-mode power supply does not replace the necessary surge protection in a system.

Accessories

Note

connectPower
Single-phase

CP SNT 48W 24V 2A

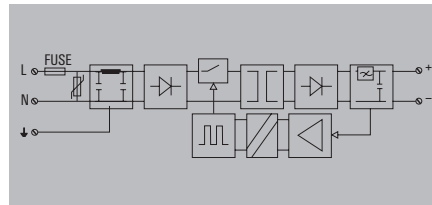
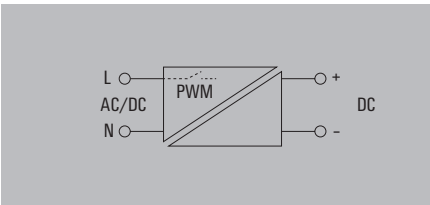
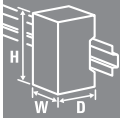

Technical data

Input

Input voltage
Input current
Input frequency
Turn-on current limit
Input fuse

85...264 V AC / 110...370 V DC
500 mA at rated load @ 230 V AC
50/ 60 Hz
Yes
Fuse link 2.5 A (T) / 250 V

Output

Output voltage
Output current
Output power
Max. residual ripple
Overload protection

15...28 V DC (adjustable via potentiometer)
2 A
48 W
120 mV_{SS}
105 %...150 % I_{load} of max. output load; automatic reset

Surge protection
Mains failure bridge-over time
Control at 10...100% load
Max. capacitance at output

Varistor
11 ms @ 115 V AC / 50 ms @ 230 V AC
1%
10000 µF

Insulation coordination (EN 50178)

Electrical isolation, output-earth
Electrical isolation, input-earth
Electrical isolation, input-output
Electrical isolation, I/O rail

0.5 kV
1.5 kV
3 kV
4 kV

General data

Ambient temperature (operational)
Storage temperature
Degree of efficiency at max. load
Standards
Approvals
EMC standards
Parallel connection option

-10...+70 °C (Derating ab 55 °C)
-20 °C...+85 °C
78%
DIN EN 50178 (PELV), DIN EN 60950 (SELV)
cCSAus; cURus; GOSTME25; UL
EN 55011, EN 55022, EN 61000-3-2,-3, EN 61000-6-2,-3,-4
Max. 3 devices (rated voltages are to be calibrated at ±20 mV)

Derating curve

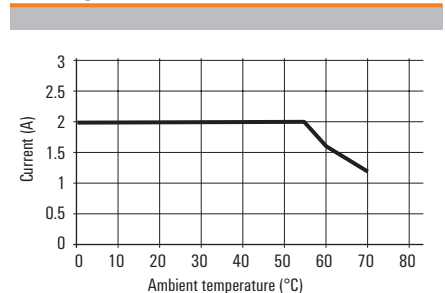

Dimensions

Clamping range (nominal / min. / max.) mm²
Depth x width x height mm

Input/Output

2.5 / 0.5 / 4
62.5 / 70 / 90.5

Note

Ordering data

Screw connection

Type	Qty.	Order No.
CP SNT 48W 24V 2A	1	8739140000

Note

The internal varistor found in a switch-mode power supply does not replace the necessary surge protection in a system.

Accessories

Note

connectPower
Single-phase

CP SNT 48W 48V 1A

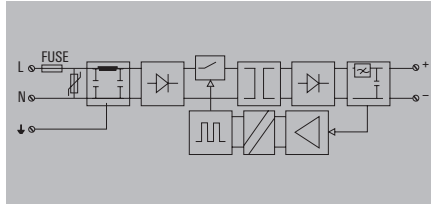
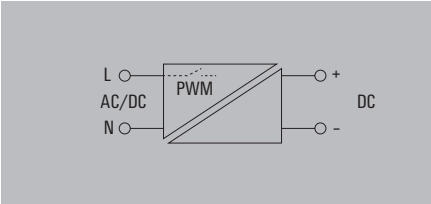
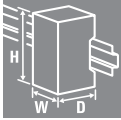

Technical data

Input

- Input voltage
- Input current
- Input frequency
- Turn-on current limit
- Input fuse

Output

- Output voltage
- Output current
- Output power
- Max. residual ripple
- Overload protection

- Surge protection
- Mains failure bridge-over time
- Control at 10...100% load
- Max. capacitance at output

Insulation coordination (EN 50178)

- Electrical isolation, output-earth
- Electrical isolation, input-earth
- Electrical isolation, input-output
- Electrical isolation, I/O rail

General data

- Ambient temperature (operational)
- Storage temperature
- Degree of efficiency at max. load
- Standards
- Approvals
- EMC standards
- Parallel connection option

Input

- 85...264 V AC / 110...370 V DC
- 500 mA at rated load @ 230 V AC
- 50/ 60 Hz
- Yes
- Fuse link 2.5 A (T) / 250 V

Output

- 46...55 V DC (adjustable via potentiometer)
- 1 A
- 48 W
- 120 mV_{SS}
- 105 %...150 % I_{const} of max. output load; automatic reset

Varistor

- 11 ms @ 115 V AC / 50 ms @ 230 V AC
- 1%
- 10000 µF

Electrical isolation

- 0.5 kV
- 1.5 kV
- 3 kV
- 4 kV

Temperature

- 10...+70 °C (Derating ab 55 °C)
- 20 °C...+85 °C

Efficiency

- 80%

Standards

- DIN EN 50178 (PELV), DIN EN 60950 (SELV)
- cCSAus; cURus; GOSTME25; UL
- EN 55011, EN 55022, EN 61000-3-2,-3, EN 61000-6-2,-3,-4
- Max. 3 devices (rated voltages are to be calibrated at ±20 mV)

Derating curve

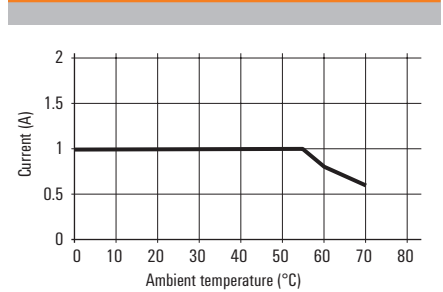

Dimensions

- Clamping range (nominal / min. / max.) mm²
- Depth x width x height mm

Input/Output

- 2.5 / 0.5 / 4
- 62.5 / 70 / 90.5

Note

Ordering data

Screw connection

Type	Qty.	Order No.
CP SNT 48W 48V 1A	1	8879230000

Note

The internal varistor found in a switch-mode power supply does not replace the necessary surge protection in a system.

Accessories

Note

Small screwdriver

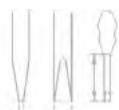

Type	Blade type	Size/AF	a	b	c	Order No.
SDIK PH1		1.00			80	9008570000
SDIS 0.5X3.0X100	B		0.5	3	100	9008380000

Markers



Type	Colour	Qty.	Order No.
SM 18/9.5 K MC NE WS	white	200	1248580000

End bracket

For DIN rail TS 35



Polyamide with fibre glass, screwable	Colour	Torque	Qty.	Order No.
WEW 35/1 SW	black	1.2 Nm	50	1162600000

connectPower WAVEPOWER

**connectPower
Single-phase**

CP SNT 12W 24V 0.5A

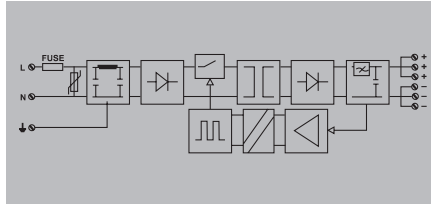
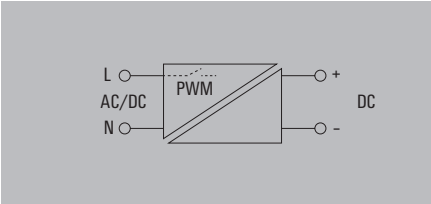
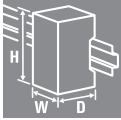

Technical data

Input	
Input voltage	85...265 V AC, 120...300 V DC
Input current	260 mA @ 115 V AC; 180 mA @ 230 V AC
Input frequency	50/ 60 Hz
Input fuse	2 A time-lag fuse (internal)
Surge protection	Varistor
Output	
Output voltage	24 V DC
Output current	0.5 A
Output power	12 W
Max. residual ripple	0.1 %
Overload protection	Surge current / thermal cut-out
Surge protection	Varistor
Mains failure bridge-over time	30 ms @ 115 V AC / 80 ms @ 230 V AC
Control at 10...100% load	0.6%
Parallel connection option	No
Insulation coordination (EN 50178)	
Electrical isolation, output-earth	0.5 kV
Electrical isolation, input-earth	1.5 kV
Electrical isolation, input-output	3 kV
Electrical isolation, I/O rail	4 kV
General data	
Ambient temperature (operational)	-20...+50 °C
Storage temperature	-40 °C...+85 °C
Degree of efficiency at max. load	80%
Status indication	Green LED
Standards	DIN EN 50178, DIN EN 60950, IEC950
EMC standards	IEC 61000-6 /2, -3
Power factor correction	No
Approvals	CE; CSA; cULus; GOSTME25

Input/Output		
Clamping range (nominal / min. / max.)	mm ²	2.5 / 0.5 / 2.5
Depth x width x height	mm	112.4 / 22.5 / 92.4
Note		

Dimensions

Clamping range (nominal / min. / max.)	mm ²	2.5 / 0.5 / 2.5
Depth x width x height	mm	112.4 / 22.5 / 92.4

Note

Ordering data

Screw connection

Type	Qty.	Order No.
CP SNT 12W 24V 0.5A	1	9918840024

Note

The internal varistor found in a switch-mode power supply does not replace the necessary surge protection in a system.

Accessories

Note

Supply voltage 24 V and 0 V can be cross-connected with ZQV 2.5N/2

connectPower DC/DC converter

connectPower

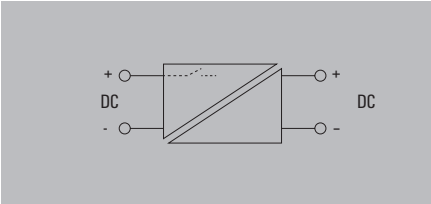
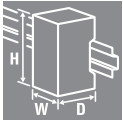

CP DCDC 50W 22-24V 2A

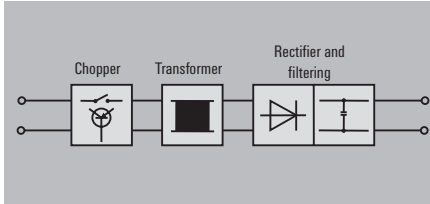

CP DCDC 50W 12V 3A

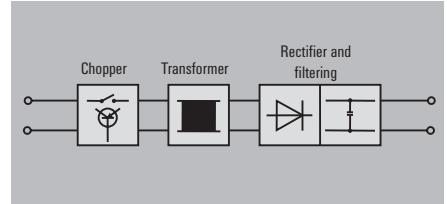

Technical data

Input
Input voltage
Input fuse
Output
Output voltage
Output current
Overload protection
General data
Ambient temperature (operational)
Storage temperature
Status indication
Switching frequency
Approvals

Input voltage	18...30 V DC, typ. 24 V DC
Input fuse	internal
Output voltage	22...24 V DC
Output current	2 A
Overload protection	Surge current cut-out with self-reset
Ambient temperature (operational)	-10...+60 °C (Derating ab 50 °C)
Storage temperature	-40 °C...+85 °C
Status indication	Green LED
Switching frequency	200 kHz
Approvals	CE; CSA; CSAEX; cULus

Input voltage	10...14 V DC, typ. 12V DC
Input fuse	internal
Output voltage	10.5...14.5 V DC
Output current	3 A
Overload protection	Surge current cut-out with self-reset
Ambient temperature (operational)	-10...+60 °C (Derating ab 50 °C)
Storage temperature	-40 °C...+85 °C
Status indication	Green LED
Switching frequency	200 kHz
Approvals	CE; CSA; CSAEX; cULus

Dimensions	
Clamping range (nominal / min. / max.)	mm ²
Depth x width x height	mm
Note	

Input/Output
4 / 0.1 / 4
131 / 57 / 98

Input/Output
4 / 0.1 / 4
131 / 57 / 98

Ordering data

Screw connection

Type	Qty.	Order No.
CP DCDC 50W 22-24V 2A	1	9919372424

Type	Qty.	Order No.
CP DCDC 50W 12V 3A	1	9919371212

Note

--

--

Accessories

Note

Bracket for wall mounting: 7920560000

Bracket for wall mounting: 7920560000

CP DCDC 50W 20-24V 2A

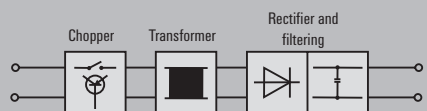

10...14 V DC, typ. 12V DC internal
20.5...29.5 V DC
2 A
Surge current cut-out with self-reset
-10...+60 °C (Derating ab 50 °C)
-40 °C...+85 °C
Green LED
200 kHz
CE; CSA; CSAEX; cULus

CP DCDC 50W 15V 3A

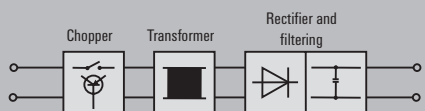

10...14 V DC, typ. 12V DC internal
13...18 V DC
3 A
Surge current cut-out with self-reset
-10...+60 °C (Derating ab 50 °C)
-40 °C...+85 °C
Green LED
200 kHz
CE; CSA; CSAEX; cULus

CP DCDC 50W 12V 3A

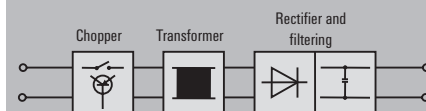

18...30 V DC, typ. 24 V DC internal
10.5...14.5 V DC
3 A
Surge current cut-out with self-reset
-10...+60 °C (Derating ab 50 °C)
-40 °C...+85 °C
Green LED
200 kHz
CE; CSA; CSAEX; cULus

Input/Output
4 / 0.1 / 4
131 / 57 / 98

Input/Output
4 / 0.1 / 4
131 / 57 / 98

Input/Output
4 / 0.1 / 4
131 / 57 / 98

Type	Qty.	Order No.
CP DCDC 50W 22-24V 2A	1	9919371224

Type	Qty.	Order No.
CP DCDC 50W 15V 3A	1	9919371215

Type	Qty.	Order No.
CP DCDC 50W 12V 3A	1	9919372412

Bracket for wall mounting: 7920560000

Bracket for wall mounting: 7920560000

Bracket for wall mounting: 7920560000

connectPower DC/DC converter

connectPower

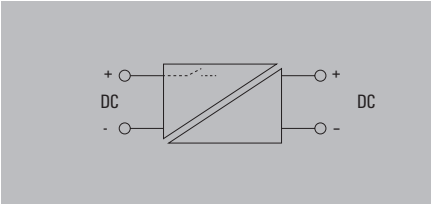
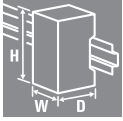

Technical data

Input
Input voltage
Input fuse
Output
Output voltage
Output current
Overload protection
General data
Ambient temperature (operational)
Storage temperature
Status indication
Switching frequency
Approvals

CP DCDC 50W 15V 3A

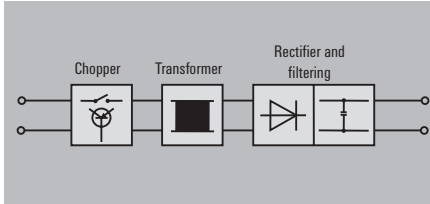

Input voltage	18...30 V DC, typ. 24 V DC
Input fuse	internal
Output voltage	15 V DC
Output current	3 A
Overload protection	Surge current cut-out with self-reset
Ambient temperature (operational)	-10...+60 °C (Derating ab 50 °C)
Storage temperature	-40 °C...+85 °C
Status indication	Green LED
Switching frequency	200 kHz
Approvals	CE; CSA; CSAEX; cULus

CP DCDC 50W 5V 8A

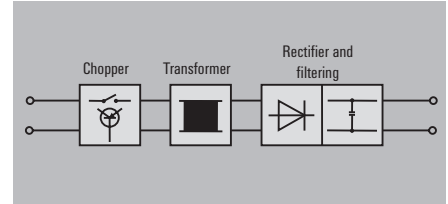

Input voltage	18...30 V DC, typ. 24 V DC
Input fuse	internal
Output voltage	5 V DC
Output current	8 A
Overload protection	Surge current cut-out with self-reset
Ambient temperature (operational)	-10...+60 °C (Derating ab 50 °C)
Storage temperature	-40 °C...+85 °C
Status indication	Green LED
Switching frequency	200 kHz
Approvals	CE; CSA; CSAEX; cULus

Dimensions	
Clamping range (nominal / min. / max.)	mm ²
Depth x width x height	mm
Note	

Input/Output	
4 / 0.1 / 4	
131 / 57 / 98	

Input/Output	
4 / 0.1 / 4	
131 / 57 / 98	

Ordering data

	Screw connection
--	------------------

Type	Qty.	Order No.
CP DCDC 50W 15V 3A	1	9919372415

Type	Qty.	Order No.
CP DCDC 50W 5V 8A	1	9919372405

Note	
-------------	--

Accessories

Note	
-------------	--

--	--

Note	Bracket for wall mounting: 7920560000
-------------	---------------------------------------

--	--

Note	Bracket for wall mounting: 7920560000
-------------	---------------------------------------

connectPower DC/DC converter

DC voltage converter for preparation and potential isolation in 24 V DC systems

- Overvoltage category III
- Class III protection
- Status of relay contact
- DC OK transistor output

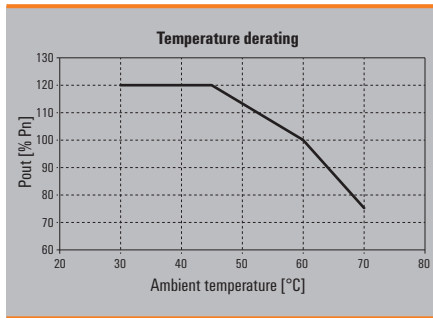

Technical data

General technical specifications	
Output characteristic curve / current limit	IU / > 120 % I _R
Earth discharge current	< 0.005 mA
Ambient temp. Operating / storage temperature	-25 °C ... +70 °C / -40 °C ... +85 °C
Max. permitted humidity (operational)	5 %...95 % RH
Protection degree	IP 20
Class of protection	III
Contamination degree	2
Insulation voltage	2.5 kV AC 1 min. / 1.5 kV AC 1 min. / 0.5 kV AC 1 min.
Overvoltage category	III
MTBF	> 500,000 hrs. according to IEC 1709 (SN29500)
Protection against load reverse voltages	33...34 V DC
Parallel capability (without diode module)	Yes, max. 5
Mountable side-by-side without gaps	Yes
Housing version, metal	Resistant to corrosion
Signal operations	LED green / red
Mounting position, installation notice	Horizontal on TS 35 DIN rail, above and below 50 mm Clearance for air circulation, suitable for aligning without clearance gap For installation in rotating systems
Metal clip-on foot	Yes
EMC / shock / vibration	
Noise emission according to EN55022	Class B
Interference immunity tests, according to	EN61000-4-2 (ESD), EN61000-4-3 and EN61000-4-8 (Fields), EN61000-4-4 (Burst), EN61000-4-5 (Surge), EN61000-4-6 (conducted), EN61000-4-11 (Dips)
Limiting of mains voltage harmonic currents	According to EN 61000-3-2
Resistance against vibration and shock	According to EN50178, shock: 5 g in all directions
Electrical safety (applied standards)	
Electrical equipment of machines	According to EN60204
Safety transformers for switched-mode power units	According to EN61558-2-17
Machinery with electronic equipment	According to EN50178 / VDE0160
Safety extra-low voltage	SELV according to EN60950, PLEV according to EN60204
Protective separation / protection against electrical shock	VDE0100-410 / according to DIN57100-410
Protection against dangerous shock currents	According to VDE0106-101

Accessories

Type	Qty.	Order No.
Diode module (for redundant power supply)	1	1222210000
Capacity module (for pulse triggering of circuit breakers)	1	1222240000

connectPower
DC/DC converter

CP DCDC 250W 24V 10A

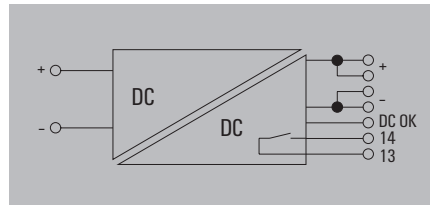
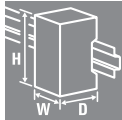

Technical data

Input	
Rated input voltage / DC input voltage range	24 V DC / 18 ... 31.2 V DC
DC current consumption	Typ.: 11 A, Max.: 15.5 A
Inrush current	Max. 10 A
Input fuse (internal)	Yes
Recommended back-up fuse	16 A / DI/II safety fuse, 16 A, Char. B circuit breaker, 16 A, Char. C circuit breaker
Output	
Rated output voltage	24 V DC ± 1 %
Output voltage	22.5 - 29.5 V DC (adjustable via potentiometer on front)
Ramp-up time	≤ 100 ms
Residual ripple, breaking spikes	< 50 mV _{SS} @ 24 V DC, I _N
Rated (nominal) output current @ U _{Nom}	10 A @ 60 °C
Short-circuit protection / Overload protection	Yes / Yes
Powerboost @ 24 V DC, 60 °C	12 A for 1 min, ED = 5 %
General data	
Degree of efficiency	typ. 91%
Power loss	Idle: max. 2 W, Nominal load: 24 W
AC failure bridging time @ I _{Nom}	> 7 ms @ 24 V DC
Tightening torque	0.5...0.6 Nm
Reverse polarity protection	Yes
Depth x width x height / Weight	150 / 60 / 130 mm / 1250 g
Signalling	
Status indicator	LED green (DC OK): output voltage ≥ 21.6 V, LED red (fault): output voltage ≤ 20.4 V
DC OK transistor output „1“ (max. load)	Output voltage ≥ 21.6 V (max. 250 mA)
DC OK transistor output „0“ / DC OK short circuit resistant	Output voltage ≤ 20.4 V / Yes
Floating contact	Yes
Contact load (NO contact)	max. 30 V DC / 0,5 A
Relay off	Output voltage > 21.6 V / < 20.4 V
Approvals	
Approvals	cULus; GL; TUEV
Connection data	
Wire connection method	Screw connection
Number of terminals	2 for (+-) / 7 for (DCOK, 13, 14, +-)
Wire cross-section, rigid min/max	0.5 / 6
Wire cross-section, flexible min/max	0.5 / 2.5
Wire cross-section, AWG/kcmil min/max	26 / 12
Note	

Input	Output
Screw connection	Screw connection
2 for (+-)	7 for (DCOK, 13, 14, +-)
0.5 / 6	0.5 / 6
0.5 / 2.5	0.5 / 2.5
26 / 12	26 / 12

Ordering data

Type	Qty.	Order No.
CP DCDC 250W 24V 10A	1	1313320010

Note

Accessories

Note

Uninterruptible power supplies (UPS)

Uninterruptible power supplies (UPS)	Overview	B.2
	UPS control unit	B.4
	Battery modules	B.6
	Buffer modules	B.8

B

Uninterruptible power supplies

Weidmüller's uninterruptible power supplies reliably protect 24 V DC consumers from voltage drop-outs and dips, such as those that could occur as a result of mains faults. These products therefore play a key role in increasing systems availability.

The buffer module is the perfect solution for bridging short-term power supply failures or dips of up to 100 ms. The capacitor-based technology enables maintenance-free operation, depending on the application, of up to 10 years.

The UPS control unit, together with the accompanying battery module and the power supply, form a complete DC UPS system with support times in minutes or hours. The modular construction allows for the overall load to be distributed into non-safe and safe load circuits, such that often a smaller UPS can be designed.

A huge variety of operating types are available to suit the particular application precisely. A remote input to block battery operation, as well as multiple signal outputs, enable remote operation of the UPS.

UPS with battery module

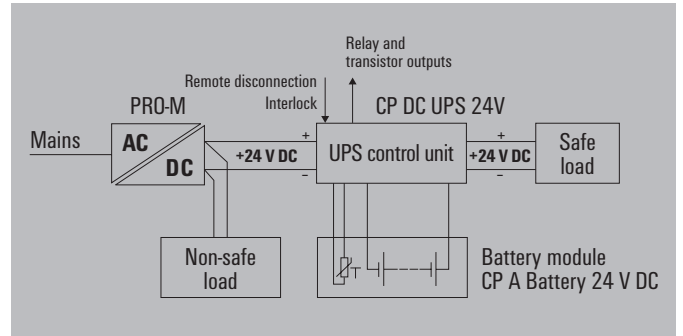

UPS with buffer module

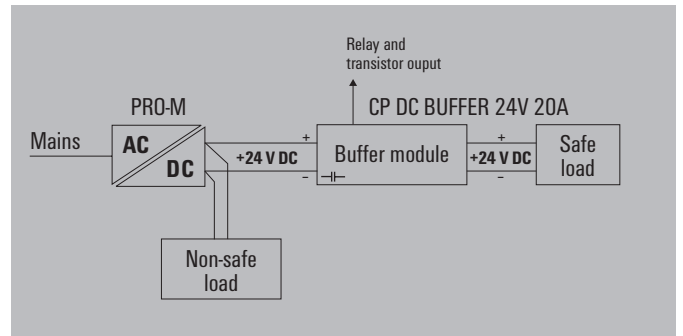

Can your facility afford to experience a power failure? Allow us to connect you so that you are safe from failure and downtime.

Let's connect.

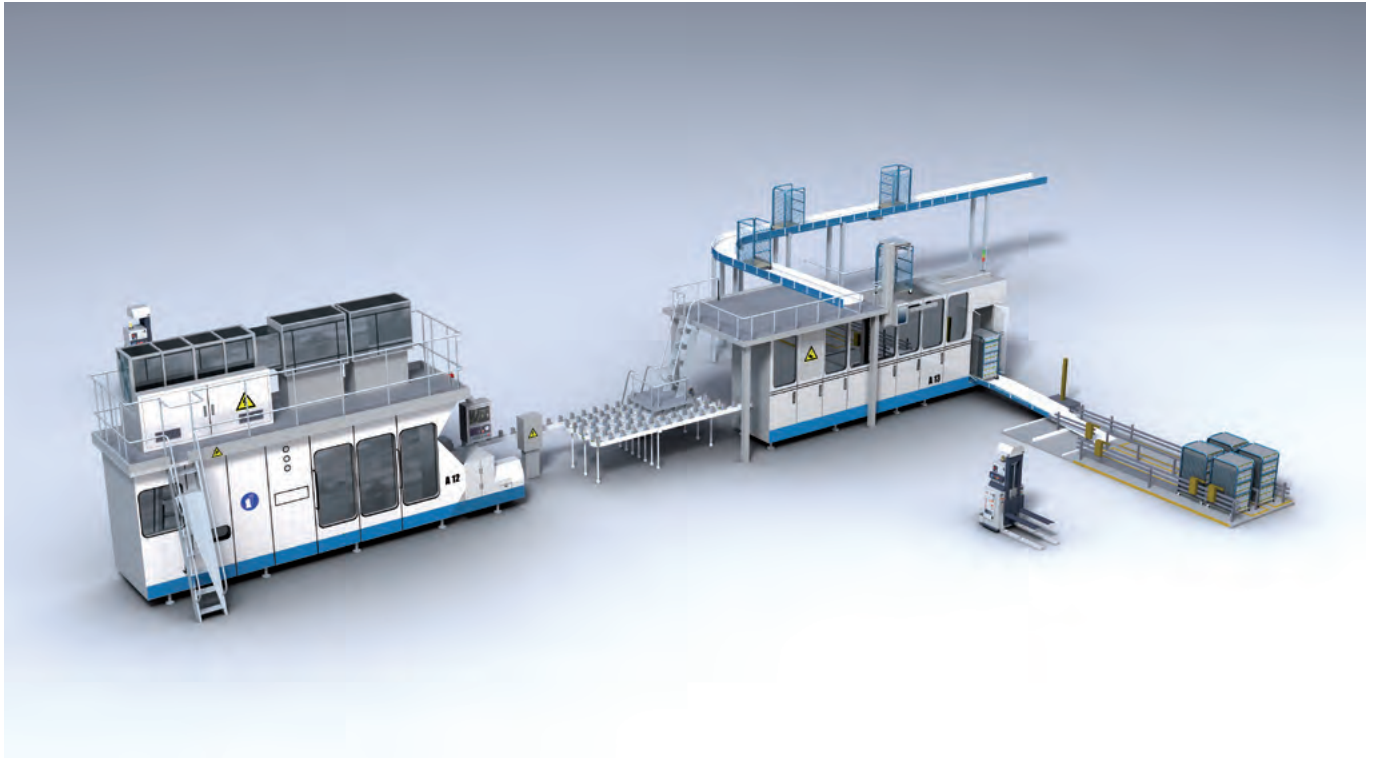

It is critical to safeguard a facility's power supply in the event of an outage. You cannot do without the important signals from the field, which serve to control the entire process. In addition, you also need to monitor a whole range of functions and performance parameters for your facility. Our highly modular power supply concept will support you in the practical fulfilment of all your requirements. At the same time, we will also familiarise ourselves with your future requirements and provide you with an individual, tailor-made solution, with components that are precisely aligned to work with one another.

For a continual, lasting power supply and clean control voltage, we use redundant circuits, selective short-circuit solutions, battery reservoirs and DC/DC converters. And because lightning and power surges can put an uninterrupted power supply in a production facility at risk, we also provide lightning and overvoltage protection. The VPU series provides unrestricted operation of power supplies and automation devices such as sensors, actuators and control units. The subsequent availability of the power supply means that all devices will restart in a controlled manner. Let's connect.



PRO-M

- Used to save space in automation technology
- Individual modulation of the output power
- Up to 5 devices can be switched directly, in parallel
- Optional diode modules with fault signalling
- Expanded temperature range -25 °C to 70 °C

UPS control unit

- Different status relays for status monitoring
- Direct switchover to battery operation in the event of malfunction
- Automatic reconnection to load when power recovers
- Long battery life due to integrated deep discharge protection
- Optimised charging feature

UPS control unit

- Two 24 V models in 10 A/20 A and 40 A
- Temperature-compensated charging feature for long battery life
- Integrated battery diagnostics including continuous availability test
- Status relay and additional transistor outputs for remote monitoring
- Convenient LED displays for easy error analysis



Technical data

Indication	
Status relay (max.load 30 V AC/DC 0.1 A)	Fault (alarm), battery operation (buff.), charging (charg.)
Transistor outputs (24 to 27 V DC max. load 150 mA)	Fault (alarm), battery operation (buff.), charging (charg.)
LED status indicator	Three-colour LED: battery capacities > 85 % green, > 40 % yellow, > 20 % red, < 20 % red (flashing) Green/yellow LED: normal / buffering Yellow/red LED: temperature alarm / alarm Yellow/red LED: switch-off / battery fault
General technical data	
Ambient temperature (operational)	-25 °C...+70 °C
Storage temperature	-40 °C...+85 °C
Max. perm. air humidity	5...95 %
Protection degree	IP 20
Class of protection	3
Pollution severity level	2
Overvoltage category	III
Insulation voltage input/output to housing/ground	1300 V DC 1 min (typetest)
MTBF	> 500,000 hours acc. to IEC 1709
Protection against reverse voltages from the load	32...34 V DC
Parallel connection option	Yes, only with diode module for redundancy
Housing version	Metal, corrosion resistant
Mounting position, installation notice	Horizontal on mounting rail TS 35, 50 mm above and below Space for free movement of air
Overload protection	Yes
Short-circuit protection	Yes
EMC / shock / vibration	
Interference emission	Acc. to EN55022 Class B
Interference immunity tests	Acc. to EN61000-4-2 (ESD), EN61000-4-3 and EN61000-4-8 (fields), EN61000-4-4 (burst), EN61000-4-5 (surge), EN61000-4-6 (conducted), EN61000-4-11 (dips)
Resistance against vibration and shock	Acc. to IEC60954 Vibration: 2.3 g, Acc. to IEC60068-2-31 shock: 30 g in all directions
Electrical safety (applied standards)	
Electrical equipment of machines	Acc. to EN60204
Safety transformers for switch-mode power supplies	Acc. to EN61558-2-17
Machinery with electronic equipment	Acc. to EN50178 / VDE0160
Extra-low voltage protection	SELV acc. to EN60950, PLEV acc. to EN60204

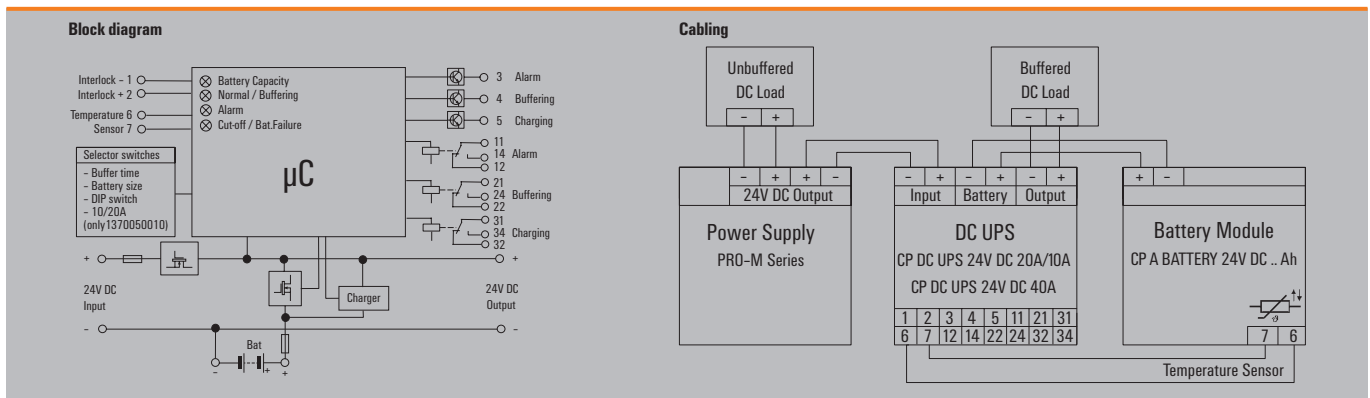

UPS control unit

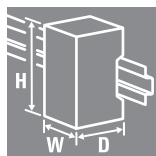

Technical data

Input	
Rated input voltage	24 V DC
Input voltage range	20...30 V DC
Rated input voltage (up to 60 °C)	≤ 13 A (for 10 A) ≤ 23 A (for 20 A)
Input current, max. (to 45 °C)	≤ 15 A (for 10 A) ≤ 27 A (for 20 A)
Input fuse	Yes, 30 A
Standby current (without battery)	max. 200 mA
Standby current (with fully charged battery)	max. 0.5 A
Reverse polarity protection	Yes
Output	
Rated output voltage	24 V DC
Output voltage, normal operation (I _{max})	V _o = V _{in} - 0.2 V
Output voltage, battery operation (I _{max})	V _o = V _{in} - 0.3 V
Rated output current (up to 60 °C)	10 A / 20 A
Continuous output current (up to 70 °C), derating from 60 °C	7.5 A / 15 A
Continuous output current (up to 45 °C)	12 A / 24 A
Power Boost@24 V DC, 60 °C	12 A / 24 A for 1 min, ED = 5 %
Integrated battery charger	
Charging feature	IU characteristic curve
Charging voltage (temperature compensated)	27, 48 V @ 20 °C
Temperature coefficient	- 48 mV / °C
Charging current	0.15 CA
Battery availability test	Yes, each minute
Battery module	
Rated voltage	24 V DC
Storage medium (AGM battery)	1.3 Ah, 3.4 Ah, 7.2 Ah, 12 Ah, 17 Ah (selectable, with rotary switch)
Parallel connection option	Yes, max. 2
Operating elements and control inputs	
Output current selector switch	10 A / 20 A
Battery in Ah selector switch	1.3 / 3.4 / 7.2 / 12 / 17 / No Battery / Service
Buffer times in minutes selector switch	0.5 / 1 / 3 / 5 / 10 / 20 / 30 / 45 / ∞ / ∞ w/0
DIP switch	Inversion of the transistor outputs; operation without temperature sensor
Remote disconnection (Interlock)	Yes
Temperature sensor connection	Yes, for NTC 10 KΩ
General data	
Buffer times	Depending on the connected battery (adjustable)
Efficiency	≥ 98 % Normal operation, battery charged ≥ 96 % Normal operation, battery charging ≥ 98 % Battery operation
Power loss	<10 W
Depth x width x height	150 / 66 / 130 mm
Weight	0.98 kg
Approvals	
CE, TÜV, cURus, cULus; Pending: GL	
Connection data	
Conductor connection system	Screw connection
Wire cross-section, rigid mm ² (min./max.)	0.5/16
Wire cross-section, flexible mm ² (min./max.)	0.5/16
Wire cross-section, AWG/kcmil (min./max.)	26/6
Stripping length (mm)	10
Tightening torque range (NM)	1.2...1.5

Ordering data

Type	Qty.	Order No.
CP DC UPS 24 V 20 A/10 A	1	1370050010

CP DC UPS 24V 20A/10A



Input	
Rated input voltage	24 V DC
Input voltage range	20...30 V DC
Rated input voltage (up to 60 °C)	≤ 13 A (for 10 A) ≤ 23 A (for 20 A)
Input current, max. (to 45 °C)	≤ 15 A (for 10 A) ≤ 27 A (for 20 A)
Input fuse	Yes, 30 A
Standby current (without battery)	max. 200 mA
Standby current (with fully charged battery)	max. 0.5 A
Reverse polarity protection	Yes
Output	
Rated output voltage	24 V DC
Output voltage, normal operation (I _{max})	V _o = V _{in} - 0.2 V
Output voltage, battery operation (I _{max})	V _o = V _{in} - 0.3 V
Rated output current (up to 60 °C)	10 A / 20 A
Continuous output current (up to 70 °C), derating from 60 °C	7.5 A / 15 A
Continuous output current (up to 45 °C)	12 A / 24 A
Power Boost@24 V DC, 60 °C	12 A / 24 A for 1 min, ED = 5 %
Integrated battery charger	
Charging feature	IU characteristic curve
Charging voltage (temperature compensated)	27, 48 V @ 20 °C
Temperature coefficient	- 48 mV / °C
Charging current	0.15 CA
Battery availability test	Yes, each minute
Battery module	
Rated voltage	24 V DC
Storage medium (AGM battery)	1.3 Ah, 3.4 Ah, 7.2 Ah, 12 Ah, 17 Ah (selectable, with rotary switch)
Parallel connection option	Yes, max. 2
Operating elements and control inputs	
Output current selector switch	10 A / 20 A
Battery in Ah selector switch	1.3 / 3.4 / 7.2 / 12 / 17 / No Battery / Service
Buffer times in minutes selector switch	0.5 / 1 / 3 / 5 / 10 / 20 / 30 / 45 / ∞ / ∞ w/0
DIP switch	Inversion of the transistor outputs; operation without temperature sensor
Remote disconnection (Interlock)	Yes
Temperature sensor connection	Yes, for NTC 10 KΩ
General data	
Buffer times	Depending on the connected battery (adjustable)
Efficiency	≥ 98 % Normal operation, battery charged ≥ 96 % Normal operation, battery charging ≥ 98 % Battery operation
Power loss	<10 W
Depth x width x height	150 / 66 / 130 mm
Weight	0.98 kg
Approvals	
CE, TÜV, cURus, cULus; Pending: GL	
Connection data	
Conductor connection system	Screw connection
Wire cross-section, rigid mm ² (min./max.)	0.5/16
Wire cross-section, flexible mm ² (min./max.)	0.5/16
Wire cross-section, AWG/kcmil (min./max.)	26/6
Stripping length (mm)	10
Tightening torque range (NM)	1.2...1.5

Type	Qty.	Order No.
CP DC UPS 24 V 20 A/10 A	1	1370050010

CP DC UPS 24V 40A



Input	
Rated input voltage	24 V DC
Input voltage range	20...30 V DC
Rated input voltage (up to 60 °C)	≤ 43 A
Input current, max. (to 45 °C)	≤ 51 A
Input fuse	Yes, 60 A
Standby current (without battery)	max. 200 mA
Standby current (with fully charged battery)	max. 0.5 A
Reverse polarity protection	Yes
Output	
Rated output voltage	24 V DC
Output voltage, normal operation (I _{max})	V _o = V _{in} - 0.2 V
Output voltage, battery operation (I _{max})	V _o = V _{in} - 0.3 V
Rated output current (up to 60 °C)	40 A
Continuous output current (up to 70 °C), derating from 60 °C	24 A
Continuous output current (up to 45 °C)	48 A
Power Boost@24 V DC, 60 °C	48 A for 1 min, ED = 5 %
Integrated battery charger	
Charging feature	IU characteristic curve
Charging voltage (temperature compensated)	27, 48 V @ 20 °C
Temperature coefficient	- 48 mV / °C
Charging current	0.15 CA
Battery availability test	Yes, each minute
Battery module	
Rated voltage	24 V DC
Storage medium (AGM battery)	3.4 Ah, 7.2 Ah, 12 Ah, 17 Ah (selectable, with rotary switch)
Parallel connection option	Yes, max. 2
Operating elements and control inputs	
Output current selector switch	No
Battery in Ah selector switch	3.4 / 7.2 / 12 / 17 / No Battery / Service
Buffer times in minutes selector switch	0.5 / 1 / 3 / 5 / 10 / 20 / 30 / 45 / ∞ / ∞ w/0
DIP switch	Inversion of the transistor outputs; operation without temperature sensor
Remote disconnection (Interlock)	Yes
Temperature sensor connection	Yes, for NTC 10 KΩ
General data	
Buffer times	Depending on the connected battery (adjustable)
Efficiency	≥ 98 % Normal operation, battery charged ≥ 96 % Normal operation, battery charging ≥ 98 % Battery operation
Power loss	<10 W
Depth x width x height	150 / 66 / 130 mm
Weight	1.0 kg
Approvals	
CE, TÜV, cURus, cULus; Pending: GL	
Connection data	
Conductor connection system	Screw connection
Wire cross-section, rigid mm ² (min./max.)	0.5/16
Wire cross-section, flexible mm ² (min./max.)	0.5/16
Wire cross-section, AWG/kcmil (min./max.)	26/6
Stripping length (mm)	10
Tightening torque range (NM)	1.2...1.5

Type	Qty.	Order No.
CP DC UPS 24 V 40 A	1	1370040010

Battery modules

- Maintenance-free lead-acid batteries from 3.4 Ah to 17 Ah
- Integrated temperature sensor for optimal battery charging
- Integrated fuse for reliable activation
- Capacity up to 40 A / 30 min or 1 A / 30 hrs
- Robust metal housing for wall mounting

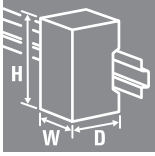

CP A BATTERY 24V DC1,3Ah



CP A BATTERY 24V DC 3,4 Ah



Technical data

Rated voltage
Nominal capacity
Max. charging current at 0.15 CA
Fuse (ATO flat blade fuse max. 80 V DC)
Buffer time

24 V DC
1.3 Ah
0.2 A
15 A
11.3 min @ 10 A
5 min @ 20 A

24 V DC
3.4 Ah
0.51 A
25 A
11.3 min @ 10 A
5 min @ 20 A

Max. output current
Parallel connection option
Series switching capability
Temperature sensor

15 A
Yes, max. 2
No
NTC 100 kΩ

25 A
Yes, max. 2
No
NTC 8 kΩ

General data

Battery type (maintenance-free battery)
Battery type Panasonic
Lifetime in years (application-dependent)
Ambient temperature
Storage temperature
Latest commissioning in months
Max. perm. air humidity
Class of protection
Protection degree
Vibration mounting rail assembly/wall mounting acc. to IEC 68-2-6
Shock mounting rail assembly/wall mounting acc. to IEC 68-2-27
Depth x width x height
Weight
Approvals

Valve Regulated Lead Acid (VRLA)- Absorbed Glass Mat (AGM)
UP-RW1220P
6...9 @ 20 °C
0°...+40 °C
-15°...+40 °C
9
5...95 %
III
IP 20
2.3 g / 2.3 g
30 g
124 / 52 / 148 mm
1.5 kg
CE; Pending: GL, UL 508

Valve Regulated Lead Acid (VRLA)- Absorbed Glass Mat (AGM)
UP-RW1220P
6...9 @ 20 °C
0°...+40 °C
-15°...+40 °C
9
5...95 %
III
IP 20
0.7 g / 0.7 g
30 g
126 / 108 / 144 mm
3.6 kg
CE, TÜV; Pending: GL, UL 508

Connection data (input/output, signal)

Screw connection
Wire cross-section, rigid mm² (min./max.)
Wire cross-section, flexible mm² (min./max.)
Wire cross-section, AWG/kcmil (min./max.)
Tightening torque range (Nm)

Input/output/battery	Signal
Pluggable	
0.2/6	0.2/4
0.25/6	0.2/4
30/12	30/12
0.5	0.2...0.25

Input/output/battery	Signal
Pluggable	
0.2/6	0.2/1.5
0.25/6	0.2/1.5
24/10	28/16
0.5...0.6	0.2...0.25

Ordering data

Type	Qty.	Order No.
CP A BATTERY 24V DC1,3Ah	1	1406930000

Type	Qty.	Order No.
CP A BATTERY 24V DC 3,4 Ah	1	1251070000

Sensor

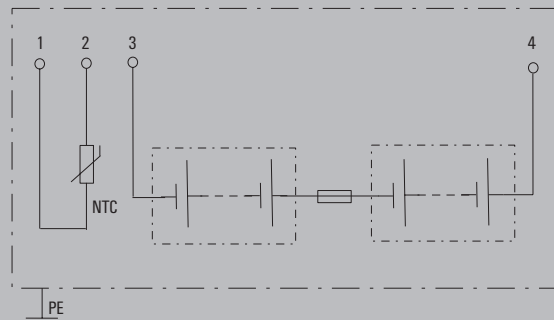

CP A BATTERY 24V DC 7,2 Ah



24 V DC	
7.2 Ah	
1.8 A	
2 x 25 A	
26.5 min @ 10 A	
11.5 min @ 20 A	
5 min @ 30 A	
50 A	
Yes, max. 2	
No	
NTC 8 kΩ	
Valve Regulated Lead Acid (VRLA)- Absorbed Glass Mat (AGM)	
LC-R127R2PG	
6...9 @ 20 °C	
0°...+40 °C	
-15°...+40 °C	
9	
5...95 %	
III	
IP 20	
- / 0.7 g	
30 g	
126 / 162 / 155 mm	
5.9 kg	
CE, TÜV; Pending: GL, UL 508	
Input/output/battery	Signal
Pluggable	
0.2/6	0.2/1.5
0.25/6	0.2/1.5
24/10	28/16
0.5...0.6	0.2...0.25

Type	Qty.	Order No.
CP A BATTERY 24V DC 7,2 Ah	1	1251080000

CP A BATTERY 24V DC 12 Ah



24 V DC	
12 Ah	
1.8 A	
2 x 25 A	
51 min @ 10 A	
22.7 min @ 20 A	
9.2 min @ 30 A	
50 A	
Yes, max. 2	
No	
NTC 8 kΩ	
Valve Regulated Lead Acid (VRLA)- Absorbed Glass Mat (AGM)	
LC-RA1212PG	
6...9 @ 20 °C	
0°...+40 °C	
-15°...+40 °C	
9	
5...95 %	
III	
IP 20	
- / 0.7 g	
30 g	
126 / 229 / 155 mm	
9.2 kg	
CE, TÜV; Pending: GL, UL 508	
Input/output/battery	Signal
Pluggable	
0.2/6	0.2/1.5
0.25/6	0.2/1.5
24/10	28/16
0.5...0.6	0.2...0.25

Type	Qty.	Order No.
CP A BATTERY 24V DC 12 Ah	1	1251090000

CP A BATTERY 24V DC 17 Ah



24 V DC	
17 Ah	
2.55 A	
2 x 25 A	
81 min @ 10 A	
34.2 min @ 20 A	
13.5 min @ 30 A	
50 A	
Yes, max. 2	
No	
NTC 8 kΩ	
Valve Regulated Lead Acid (VRLA)- Absorbed Glass Mat (AGM)	
LC-XD1217APG	
10...12 @ 20 °C	
0°...+40 °C	
-15°...+40 °C	
9	
5...95 %	
III	
IP 20	
- / 0.7 g	
30 g	
160 / 232 / 178 mm	
13.4 kg	
CE, TÜV; Pending: GL, UL 508	
Input/output/battery	Signal
Pluggable	
0.2/6	0.2/1.5
0.25/6	0.2/1.5
24/10	28/16
0.5...0.6	0.2...0.25

Type	Qty.	Order No.
CP A BATTERY 24V DC 17 Ah	1	1251110000

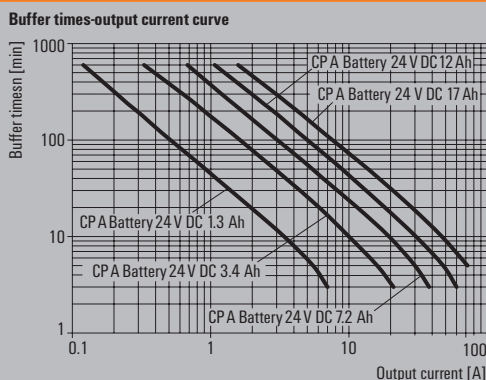

Buffer modules

- Maintenance-free UPS on capacitor basis with a capacity to support 20 A / 260 ms
- Parallel switching to increase the output current or support time
- Status notification via LED and relay contact

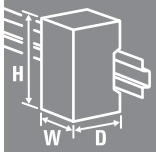

CP DC Buffer 24V 20A



Technical data

Input	
Input voltage	24 V DC (22.5...30 V DC)
Input current	0...22 A
Max. approved input current	Max. 22 A
Surge protection	35 V DC suppressor diode
Output	
Output voltage	24 V DC
Output current	20 A, max. 22 A
Parallel connection option	Yes, without diode module
Overload protection	≥ 22 A (Only at discharge)
Surge protection	31...34 V (Only at discharge)
Status relay (max. load)	Input voltage OK (30 V AC/DC 2 A) Operational (24 V AC/DC 300 mA)
Display	
Operational	LED green: ready
General data	
Efficiency	95 %
Insulation voltage input/output	1 kV
Storage medium	Internal condenser
Buffer times	260 ms at 20 A, 6 s at 1 A
MTBF	> 500,000 hours acc. to IEC 1709
Ambient temperature	-25 °C...+70 °C
Storage temperature	-40 °C...+85 °C
Max. perm. air humidity	5...95 %
Depth x width x height	150 / 66 / 130 mm
Standards applied	EN50178, EN60950
EMC	EN55011, EN55022, EN55024, EN61000-6-2,-3,-4
Weight	1.15 kg
Approvals	CE, TÜV, cURus, cULus
Connection data	
Conductor connection system	Screw connection
Wire cross-section mm ² (nominal/min./max.)	10/0.3/16 10/0.3/16 4/0.13/6

24 V DC (22.5...30 V DC)		
0...22 A		
Max. 22 A		
35 V DC suppressor diode		
24 V DC		
20 A, max. 22 A		
Yes, without diode module		
≥ 22 A (Only at discharge)		
31...34 V (Only at discharge)		
Input voltage OK (30 V AC/DC 2 A)		
Operational (24 V AC/DC 300 mA)		
LED green: ready		
95 %		
1 kV		
Internal condenser		
260 ms at 20 A, 6 s at 1 A		
> 500,000 hours acc. to IEC 1709		
-25 °C...+70 °C		
-40 °C...+85 °C		
5...95 %		
150 / 66 / 130 mm		
EN50178, EN60950		
EN55011, EN55022, EN55024, EN61000-6-2,-3,-4		
1.15 kg		
CE, TÜV, cURus, cULus		
Input	Output	Signal
Screw connection		
10/0.3/16	10/0.3/16	4/0.13/6

Ordering data

Type	Qty.	Order No.
CP DC Buffer 24V 20A	1	1251220000

Block diagram

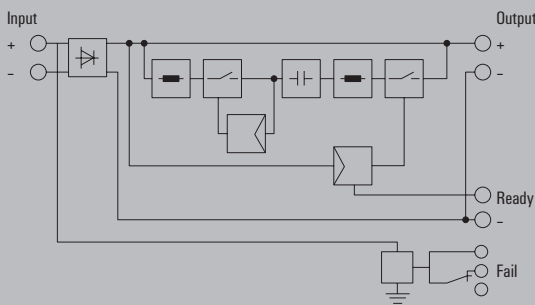

Small metal foot



Type	Order No.
MTA 30 MF	1251320000

Large metal foot



Type	Order No.
MTA 45 MF	1251310000

Small plastic foot



Type	Order No.
MTA 30 BK	1168970000

Large plastic foot



Type	Order No.
MTA 45 BK	1962250000

Small wall mounting



Type	Order No.
CP A WALLADAPTER 30 MM	1461870000

Large wall mounting



Type	Order No.
CP A WALLADAPTER 45 MM	1461850000

Temperature probe



Type	Cable length	Order No.
CP DC UPS TF25	2.5 m	1444540000
CP DC UPS TF05	0.5 m	1444480000

Small screwdriver

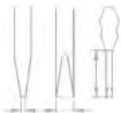

Type	Blade type	Size/AF	a	b	c	Order No.
SDIS 0.5X3.0X100	B		0.5	3	100	9008380000

Large screwdriver

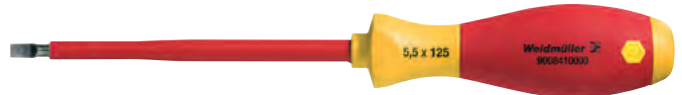

Type	Blade type	Size/AF	a	b	c	Order No.
SDIS 1.0X5.5X125	B		1	5.5	125	9008410000

Markers



Type	Colour	Qty.	Order No.
SM 18/9.5 K MC NE WS	white	200	1248580000

End bracket

For DIN rail TS 35



Type	Colour	Torque	Qty.	Order No.
Polyamide with fibre glass, screwable WEW 35/1 SW	black	1.2 Nm	50	1162600000

Fuse protection for 24 V DC circuits

Fuse protection for 24 V DC circuits	Overview	C.2
	WAVEGUARD	C.4

Fuse protection

A 24 V DC control voltage has become the standard in the automation industry. Selective fuse protection is often used when the power is being supplied by PLC-guided controllers. It divides the total load into separate, logically connected safety circuits. For example, the CPU, actuators and sensors can be separated in the load circuits. This selective load protection helps to decrease facility downtime and also to simplify troubleshooting. When a disruption (short circuit) occurs on a standard protective system, the entire power supply is interrupted. In a system using selective fuse protection, only the fuse in the one disrupted load circuit is triggered. If the fuse is triggered quick enough so that other loads (and particularly the CPU) can continue functioning properly, then various control algorithms can be used to deal with the disruption. It is then possible to shut down the facility in an orderly and controlled fashion.

A fundamental problem when using ordinary fuses is that they take a relatively long time to trigger. Usually, a

switched-mode power supply is already well over the surge-current limit (typically 120 % of I_{nom}) before its fuse triggers. Ordinary fuses are therefore not suitable for constructing a selective fuse protective system. Such systems present DC fuses with special challenges. They must be able to switch off quickly enough but they must also be able to tolerate the start-up surge currents from consumer loads. Weidmüller's electronic fuses, from our established WAVEGUARD line, are the answer to both of these challenges: they are quick acting but can also tolerate start-up currents. You can easily implement selective load protection using our WAVEGUARD models.

In addition, Weidmüller's electronic fuses feature a floating alarm contact and a reset input. This allows a PLC controller to query the status of the fuse or to perform an automated reset after troubleshooting. This provides you with a convenient method for remotely maintaining a complex facility. As a result, you save both time and money.



Resetting

The WAVEGUARD family can be reset manually or by using an external signal. They can be reset remotely by simply applying a 24 V signal pulse on the reset input. The reset occurs on the falling edge of the signal.

Note: A cyclical automatic reset is not permitted and can lead to a malfunction.

Signalling

A red LED displays when the electronic fuse has been triggered. An alert is also sent out over a floating alarm contact. A green LED signals that the unit is switched on. The alarm contact uses an NC contact.

BLOCK DIAGRAM WAVEGUARD

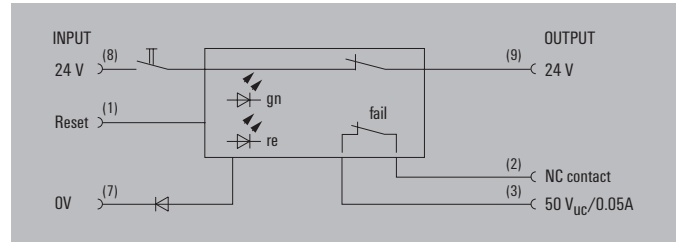

WAVEGUARD

WAVEGUARD

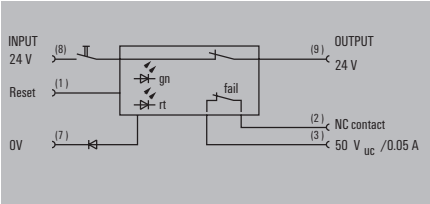
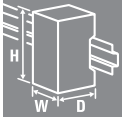

24 V DC 1.6 A

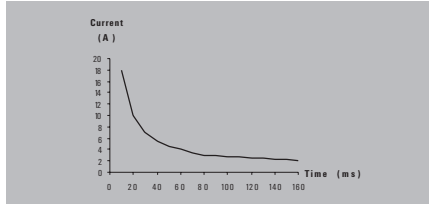

24 V DC 3.15 A

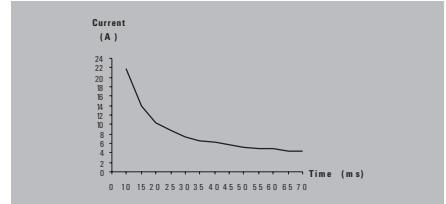

Technical data

Input
Rated control voltage
Rated current
Reset
Output
Status relay CO contact
Signalling delay
General data
Ambient temperature (operational)
Storage temperature
Status indication
Standards
EMC standards
Sliding switch
Approvals

24 V DC
1.6 A
Impulse > 100 ms +24 V, falling edge ON
NC contact, max. 50 V / 0.05 A; for low voltage only!
3.5 ms typ.
0 °C...+55 °C
-20 °C...+85 °C
LED green: OK, LED red: tripped
DIN EN 50178
EN 55011, EN 61000-6-1, 2, 4
OFF - wait 10 s - ON; on / off
cCSAus; CE; cURus; GOSTME25

24 V DC
3.15 A
Impulse > 100 ms +24 V, falling edge ON
NC contact, max. 50 V / 0.05 A; for low voltage only!
3.5 ms typ.
0 °C...+55 °C
-20 °C...+85 °C
LED green: OK, LED red: tripped
DIN EN 50178
EN 55011, EN 61000-6-1, 2, 4
OFF - wait 10 s - ON; on / off
cCSAus; CE; cURus; GOSTME25

Dimensions	
Clamping range (nominal / min. / max.)	mm ²
Depth x width x height	mm
Note	

2.5 / 0.5 / 2.5	1.5 / 0.5 / 2.5
92.4 / 22.5 / 72	92.4 / 22.5 / 72
Periodic auto-reset not permitted; Tu=23 °C, single module	

2.5 / 0.5 / 2.5	1.5 / 0.5 / 2.5
92.4 / 22.5 / 72	92.4 / 22.5 / 72
Periodic auto-reset not permitted; Tu=23 °C, single module	

Ordering data

Screw connection
Tension-clamp connection

Type	Qty.	Order No.
WGS 24Vdc 1,6A	1	8618890000
WGZ 24Vdc 1,6A	1	8621040000

Type	Qty.	Order No.
WGS 24Vdc 3,15A	1	8618910000
WGZ 24Vdc 3,15A	1	8621030000

Note

Accessories

Note

Supply voltage +24 V and 0 V can be cross-connected with ZQV 2.5 N/2
--

Supply voltage +24 V and 0 V can be cross-connected with ZQV 2.5 N/2
--

24 V DC 6.3 A

24 V DC 8 A

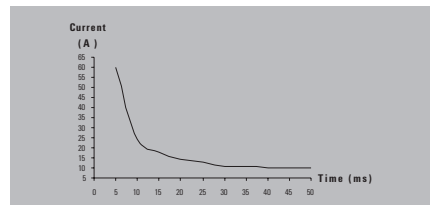
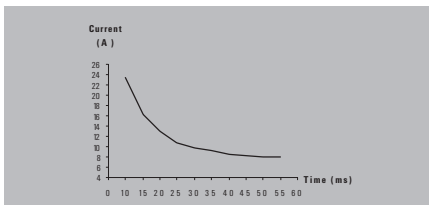
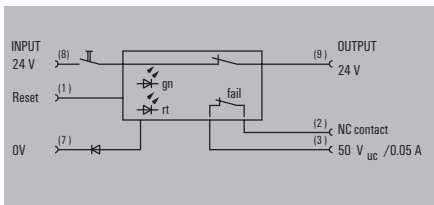
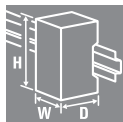

Technical data

Input
Rated control voltage
Rated current
Reset
Output
Status relay CO contact
Signalling delay
General data
Ambient temperature (operational)
Storage temperature
Status indication
Standards
EMC standards
Sliding switch
Approvals

24 V DC
6.3 A
Impulse > 100 ms +24 V, falling edge ON
NC contact, max. 50 V / 0.05 A; for low voltage only!
3.5 ms typ.
0 °C...+55 °C
-20 °C...+85 °C
LED green: OK, LED red: tripped
DIN EN 50178
EN 55011, EN 61000-6-1, 2, 4
OFF - wait 10 s - ON; on / off
cCSAus; CE; cURus; GOSTME25

24 V DC
8 A
Impulse > 100 ms +24 V, falling edge ON
NC contact, max. 50 V / 0.05 A; for low voltage only!
3.5 ms typ.
0 °C...+55 °C
-20 °C...+85 °C
LED green: OK, LED red: tripped
DIN EN 50178
EN 55011, EN 61000-6-1, 2, 4
OFF - wait 10 s - ON; on / off
cCSAus; CE; cURus; GOSTME25

Dimensions	
Clamping range (nominal / min. / max.)	mm ²
Depth x width x height	mm
Note	

2.5 / 0.5 / 2.5	1.5 / 0.5 / 2.5
92.4 / 22.5 / 72	92.4 / 22.5 / 72
Periodic auto-reset not permitted; Tu=23 °C, single module	

2.5 / 0.5 / 2.5	1.5 / 0.5 / 2.5
92.4 / 22.5 / 72	92.4 / 22.5 / 72
Periodic auto-reset not permitted; Tu=23 °C, single module	

Ordering data

Screw connection
Tension-clamp connection

Type	Qty.	Order No.
WGS 24Vdc 6,3A	1	8618930000
WGZ 24Vdc 6,3A	1	8621020000

Type	Qty.	Order No.
WGS 24Vdc 8,0A	1	8618940000
WGZ 24VDC 8,0A	1	8621010000

Note

Accessories

Note

Supply voltage +24 V and 0 V can be cross-connected with ZQV 2.5 N/2
--

Supply voltage +24 V and 0 V can be cross-connected with ZQV 2.5 N/2
--

WAVEGUARD

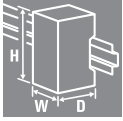

24 V DC 0.5...5 A

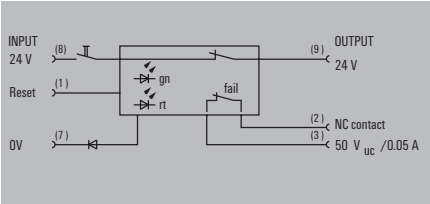

Technical data

Input
Rated control voltage
Rated current
Reset
Output
Status relay CO contact
Signalling delay
General data
Ambient temperature (operational)
Storage temperature
Status indication
Standards
EMC standards
Sliding switch
Approvals

24 V DC
0.5...5 A adjustable
Impulse > 100 ms +24 V, falling edge ON
NC contact, max. 50 V / 0.05 A; for low voltage only!
3.5 ms typ.
0 °C...+55 °C
-20 °C...+85 °C
LED green: OK, LED red: tripped
DIN EN 50178
EN 55011, EN 61000-6-1, 2, 4
OFF - wait 10 s - ON; on / off
cCSAus; CE; cURus; GOSTME25

Derating curve

Dynamic tripping characteristic

Tripping current: 0.5 A

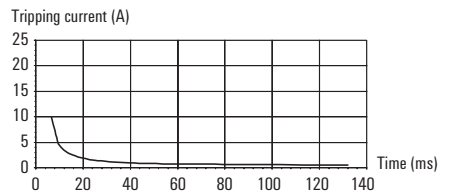

Tripping current: 5.0 A

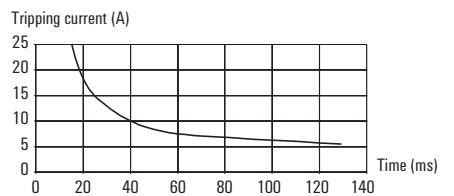

Dimensions	
Clamping range (nominal / min. / max.)	mm ²
Depth x width x height	mm
Note	

2.5 / 0.5 / 2.5	1.5 / 0.5 / 2.5
92.4 / 22.5 / 72	92.4 / 22.5 / 72
Periodic auto-reset not permitted; Tu=23 °C, single module	

Ordering data

Screw connection
Tension-clamp connection

Type	Qty.	Order No.
WGS 24Vdc 0.5...5A	1	8710270000
WGZ 24Vdc 0.5...5A	1	8727630000

Note

Accessories

Note

Supply voltage +24 V and 0 V can be cross-connected with ZQV 2.5 N/2
--

Unregulated power supplies

Unregulated power supplies	Overview	D.2
	compactPower	D.4



Unregulated power supplies – compactPower

Compact power supply units are important links in the power supplies for controllers. They are used where processes or control voltages are required that vary from the mains voltage. Transformers provide the electrical isolation between the input circuit and the output circuit. The minimum requirement (to VDE 0550) is 2,000 V. Screw terminals secure the input-side connection to the mains. The single-phase devices are rated for a nominal voltage of $\sim 230 \pm \sim 15 \text{ V}$, or $\sim 400 \text{ V} \pm \sim 15 \text{ V}$, 50/60 Hz, the 3-phase devices for $3 \times 400 \text{ V} \pm 5 \%$. The secondary DC voltage from the transformer is conducted to a bridge rectifier where it is rectified.

The pulsating DC voltage is then fed from the rectifier and filtered to a low residual ripple by means of an electrolytic capacitor.

This DC voltage is then fed to the output terminal. These are designed as pluggable screw terminals. A varistor is integrated in the output circuitry to attenuate voltage peaks. The operating status is indicated by means of a green LED via the output circuit. Devices with 600 W and higher are equipped with a fan.

D

Single-phase unregulated power supplies



Three-phase unregulated power supplies



Well-balanced spectrum for optimum economy

The output currents of these practical products are defined by way of two ambient temperatures. Size selection is based on the maximum effectiveness of the components.

Adapted to standard voltages in accordance with IEC 38

By choosing the appropriate terminals, the ± 15 V tapping capability allows the single-phase devices to be connected to six different nominal AC voltages: 215, 230, 245, 385, 400, 415 V.

The ± 5 % tapping capability allows the 3-phase devices to be connected to three different nominal voltages: 380, 400, 415 V.

Reliable short-circuit and overload protection

Integrated on the secondary side in device sizes up to CP NT 192 W, the FKS fuse protects against overloads and shortcircuits. For the devices CP NT 264 W and CP NT 432 W, this protection is achieved by means of a thermostatic switch built into the transformer.

Easy mounting

Keyhole assembly simplifies mounting and saves time. A snap-on fixing attachment for 35 mm DIN rails is available as an accessory for single-phase devices up to 144 W. Simply plugged into the device and secured with two screws, it ensures easiest possible mounting!

Transformers, vacuum-impregnated, painted black

- No humming
- Moisture cannot ingress into the windings
- Windings mechanically secured
- Improved heat dissipation from the windings
- Good heat dissipation

Block diagram for single-phase devices CP NT

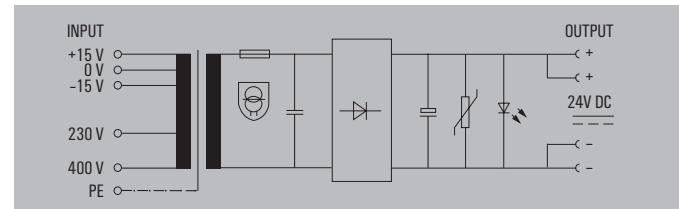

Block diagram for 3-phase devices CP NT3 250 / 400 / 500 W

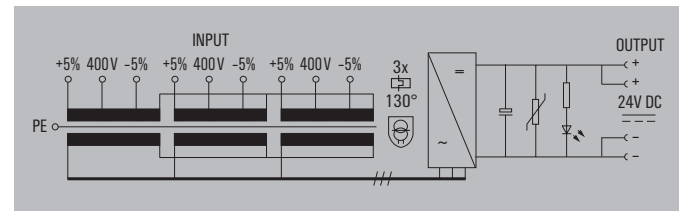

Block diagram for 3-phase devices CP NT3 600 / 750 / 1.000 W

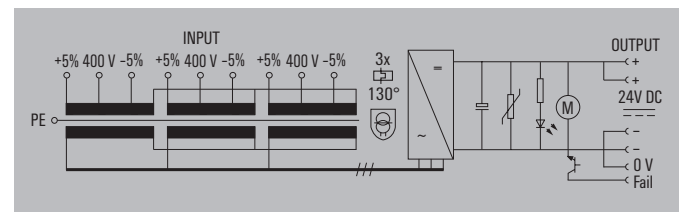

Unregulated power supplies
single-phase



Unregulated power supplies
3-phase

compactPower

compactPower single-phase

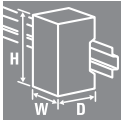

CP NT 36



CP NT 72

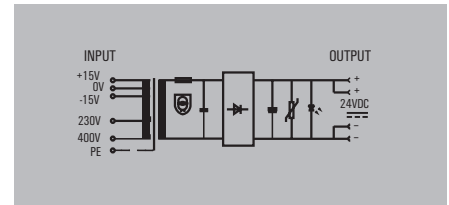
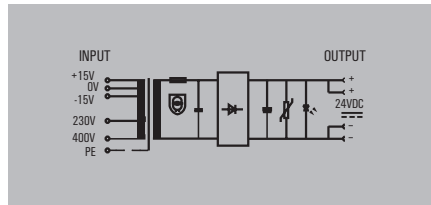

D

Technical data

Input	
Input voltage	230 V / 400 V ± 15 V
Input current	0.35 A / 0.2 A
Input frequency	50 / 60 Hz
No-load input current	0.1 A / 0.06 A
Ext. Back-up fuse	0.63 A / 0.315 A time-lag
Output	
Output voltage	24 V SELV
Output current at 40°C	1.5 A
Output current at 55°C	1 A
Output power	36 W
Max. residual ripple	< 5 %
Fuse, max.	3 A time-lag flat cable-lug fuse
Protective circuit, load side	Varistor
Insulation coordination (EN 50178)	
Electric shock protection	acc. to BGV A3
Insulation strength	4 kV
Insulation class	B
Protection degree	IP 20
Class of protection	I
General data	
Ambient temperature (operational)	-20 °C...+55 °C
Storage temperature	-20 °C...+80 °C
Degree of efficiency at max. load	80%
Mounting position, installation notice	Arbitrary, horizontally, on terminal rail TS 35
Installation advice	Direct mounting, TS 35 with clip-on plate
Status indication	Green LED
Weight	1.5 kg
Standards	DIN EN 60950, DIN EN 61558-2-4, -6, 72/23/EWG
EMC standards	EN 61000-6 /-2, -3
Approvals	CE; cULus

Input	
Input voltage	230 V / 400 V ± 15 V
Input current	0.56 A / 0.32 A
Input frequency	50 / 60 Hz
No-load input current	0.13 A / 0.08 A
Ext. Back-up fuse	0.1 A / 0.63 A time-lag
Output	
Output voltage	24 V SELV
Output current at 40°C	3 A
Output current at 55°C	2.5 A
Output power	72 W
Max. residual ripple	< 5 %
Fuse, max.	7.5 A time-lag flat cable-lug fuse
Protective circuit, load side	Varistor
Insulation coordination (EN 50178)	
Electric shock protection	acc. to BGV A3
Insulation strength	4 kV
Insulation class	B
Protection degree	IP 20
Class of protection	I
General data	
Ambient temperature (operational)	-20 °C...+55 °C
Storage temperature	-20 °C...+80 °C
Degree of efficiency at max. load	83%
Mounting position, installation notice	Arbitrary, horizontally, on terminal rail TS 35
Installation advice	Direct mounting, TS 35 with clip-on plate
Status indication	Green LED
Weight	2.1 kg
Standards	DIN EN 60950, DIN EN 61558-2-4, -6, 72/23/EWG
EMC standards	EN 61000-6 /-2, -3
Approvals	CE; cULus

Input	
Input voltage	230 V / 400 V ± 15 V
Input current	0.56 A / 0.32 A
Input frequency	50 / 60 Hz
No-load input current	0.13 A / 0.08 A
Ext. Back-up fuse	0.1 A / 0.63 A time-lag
Output	
Output voltage	24 V SELV
Output current at 40°C	3 A
Output current at 55°C	2.5 A
Output power	72 W
Max. residual ripple	< 5 %
Fuse, max.	7.5 A time-lag flat cable-lug fuse
Protective circuit, load side	Varistor
Insulation coordination (EN 50178)	
Electric shock protection	acc. to BGV A3
Insulation strength	4 kV
Insulation class	B
Protection degree	IP 20
Class of protection	I
General data	
Ambient temperature (operational)	-20 °C...+55 °C
Storage temperature	-20 °C...+80 °C
Degree of efficiency at max. load	83%
Mounting position, installation notice	Arbitrary, horizontally, on terminal rail TS 35
Installation advice	Direct mounting, TS 35 with clip-on plate
Status indication	Green LED
Weight	2.1 kg
Standards	DIN EN 60950, DIN EN 61558-2-4, -6, 72/23/EWG
EMC standards	EN 61000-6 /-2, -3
Approvals	CE; cULus

Dimensions	
Clamping range (nominal / min. / max.)	mm ²
Depth x width x height	mm
Note	

Input	Output
2.5 / 0.13 / 2.5	2.5 / 0.5 / 4
68 / 78 / 123	68 / 78 / 123

Input	Output
2.5 / 0.13 / 2.5	2.5 / 0.5 / 4
85 / 84 / 125	85 / 84 / 125

Ordering data

Screw connection

Type	Qty.	Order No.
CP NT 36W 24V 1.5A	1	8575260000

Type	Qty.	Order No.
CP NT 72W 24V 3A	1	8575270000

Note

Note

Note

Accessories

Note

Clip-in plate for TS35: 8588900000

Clip-in plate for TS35: 8588910000

compactPower single-phase

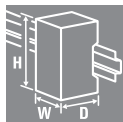

CP NT 144



CP NT 192

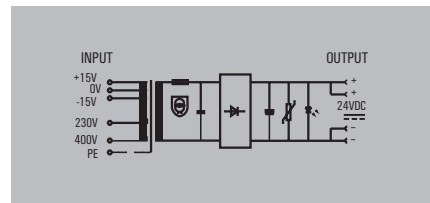
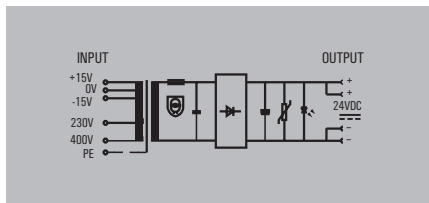

Technical data

Input	
Input voltage	230 V/ 400 V ±15 V
Input current	0.95 A/ 0.55 A
Input frequency	50/ 60 Hz
No-load input current	0.33 A / 0.19 A
Ext. Back-up fuse	1.6 A / 1.0 A time-lag
Output	
Output voltage	24 V SELV
Output current at 40°C	6 A
Output current at 55°C	5 A
Output power	144 W
Max. residual ripple	< 5 %
Fuse, max.	10 A time-lag flat cable-lug fuse
Protective circuit, load side	Varistor
Insulation coordination (EN 50178)	
Electric shock protection	acc. to BGV A3
Insulation strength	4 kV
Insulation class	B
Protection degree	IP 20
Class of protection	I
General data	
Ambient temperature (operational)	-20 °C...+55 °C
Storage temperature	-20 °C...+80 °C
Degree of efficiency at max. load	88%
Mounting position, installation notice	Arbitrary, horizontally, on terminal rail TS 35
Installation advice	Direct mounting, TS 35 with clip-on plate
Status indication	Green LED
Weight	3.1 kg
Standards	DIN EN 60950, DIN EN 61558-2-4, -6, 72/23/EWG
EMC standards	EN 61000-6 /2, -3
Approvals	CE; cULus

Input		Output	
230 V/ 400 V ±15 V		2.5 / 0.13 / 2.5	2.5 / 0.5 / 4
0.95 A/ 0.55 A		92 / 96 / 135	92 / 96 / 135
50/ 60 Hz			
0.33 A / 0.19 A			
1.6 A / 1.0 A time-lag			
24 V SELV			
6 A			
5 A			
144 W			
< 5 %			
10 A time-lag flat cable-lug fuse			
Varistor			
acc. to BGV A3			
4 kV			
B			
IP 20			
I			
-20 °C...+55 °C			
-20 °C...+80 °C			
88%			
Arbitrary, horizontally, on terminal rail TS 35			
Direct mounting, TS 35 with clip-on plate			
Green LED			
3.1 kg			
DIN EN 60950, DIN EN 61558-2-4, -6, 72/23/EWG			
EN 61000-6 /2, -3			
CE; cULus			

Input		Output	
230 V/ 400 V ±15 V		2.5 / 0.13 / 2.5	2.5 / 0.5 / 4
1.3 A/ 0.7 A		105 / 105 / 145	105 / 105 / 145
50/ 60 Hz			
0.3 A / 0.16 A			
2.0 A / 1.25 A time-lag			
24 V SELV			
8 A			
7 A			
192 W			
< 5 %			
15 A time-lag flat cable-lug fuse			
Varistor			
acc. to BGV A3			
4 kV			
B			
IP 20			
I			
-20 °C...+55 °C			
-20 °C...+80 °C			
90%			
Direct mounting			
Green LED			
4.3 kg			
DIN EN 60950, DIN EN 61558-2-4, -6, 72/23/EWG			
EN 61000-6 /2, -3			
CE; cULus			

Dimensions	
Clamping range (nominal / min. / max.)	mm ²
Depth x width x height	mm
Note	

Input	Output
2.5 / 0.13 / 2.5	2.5 / 0.5 / 4
92 / 96 / 135	92 / 96 / 135

Input	Output
2.5 / 0.13 / 2.5	2.5 / 0.5 / 4
105 / 105 / 145	105 / 105 / 145

Ordering data

Type	Qty.	Order No.
Screw connection		

Type	Qty.	Order No.
CP NT 144W 24V 6A	1	8575280000

Type	Qty.	Order No.
CP NT 192W 24V 8A	1	8575300000

Note

Note

Note

Accessories

Note

Note
Clip-in plate for TS 35: 8588920000

Note

compactPower

compactPower single-phase

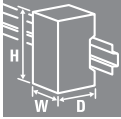

CP NT 264



CP NT 432

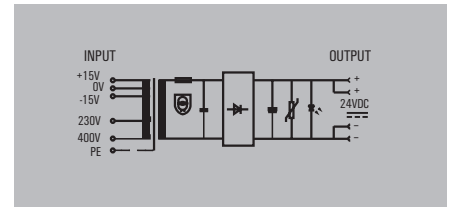
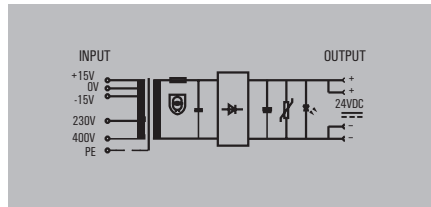

D

Technical data

Input	
Input voltage	230 V/ 400 V ±15 V
Input current	1.8 A/ 1 A
Input frequency	50/ 60 Hz
No-load input current	0.5 A / 0.28 A
Ext. Back-up fuse	3.15 A / 1.6 A time-lag
Output	
Output voltage	24 V SELV
Output current at 40°C	11 A
Output current at 55°C	10 A
Output power	264 W
Max. residual ripple	< 5 %
Fuse, max.	Thermostatic switch
Protective circuit, load side	Varistor
Insulation coordination (EN 50178)	
Electric shock protection	acc. to BGV A3
Insulation strength	4 kV
Insulation class	B
Protection degree	IP 20
Class of protection	I
General data	
Ambient temperature (operational)	-20 °C...+55 °C
Storage temperature	-20 °C...+80 °C
Degree of efficiency at max. load	93%
Installation advice	Direct mounting
Status indication	Green LED
Weight	6.1 kg
Standards	DIN EN 60950, DIN EN 61558-2-4, -6, 72/23/EWG
EMC standards	EN 61000-6 /2, -3
Approvals	CE; cULus

Input	
Input voltage	230 V/ 400 V ±15 V
Input current	1.8 A/ 1 A
Input frequency	50/ 60 Hz
No-load input current	0.5 A / 0.28 A
Ext. Back-up fuse	3.15 A / 1.6 A time-lag
Output	
Output voltage	24 V SELV
Output current at 40°C	11 A
Output current at 55°C	10 A
Output power	264 W
Max. residual ripple	< 5 %
Fuse, max.	Thermostatic switch
Protective circuit, load side	Varistor
Insulation coordination (EN 50178)	
Electric shock protection	acc. to BGV A3
Insulation strength	4 kV
Insulation class	B
Protection degree	IP 20
Class of protection	I
General data	
Ambient temperature (operational)	-20 °C...+55 °C
Storage temperature	-20 °C...+80 °C
Degree of efficiency at max. load	93%
Installation advice	Direct mounting
Status indication	Green LED
Weight	6.1 kg
Standards	DIN EN 60950, DIN EN 61558-2-4, -6, 72/23/EWG
EMC standards	EN 61000-6 /2, -3
Approvals	CE; cULus

Input	
Input voltage	230 V/ 400 V ±15 V
Input current	2.5 A/ 1.3 A
Input frequency	50/ 60 Hz
No-load input current	0.54 A / 0.31 A
Ext. Back-up fuse	4.0 A / 2.0 A time-lag
Output	
Output voltage	24 V SELV
Output current at 40°C	18 A
Output current at 55°C	15 A
Output power	432 W
Max. residual ripple	< 5 %
Fuse, max.	Thermostatic switch
Protective circuit, load side	Varistor
Insulation coordination (EN 50178)	
Electric shock protection	acc. to BGV A3
Insulation strength	4 kV
Insulation class	B
Protection degree	IP 20
Class of protection	I
General data	
Ambient temperature (operational)	-20 °C...+55 °C
Storage temperature	-20 °C...+80 °C
Degree of efficiency at max. load	95%
Installation advice	Direct mounting
Status indication	Green LED
Weight	9.1 kg
Standards	DIN EN 60950, DIN EN 61558-2-4, -6, 72/23/EWG
EMC standards	EN 61000-6 /2, -3
Approvals	CE; cULus

Dimensions	
Clamping range (nominal / min. / max.)	mm ²
Depth x width x height	mm
Note	

Input	Output
2.5 / 0.13 / 2.5	2.5 / 0.5 / 4
113 / 120 / 165	113 / 120 / 165
Note	

Input	Output
2.5 / 0.13 / 2.5	2.5 / 0.5 / 4
135 / 135 / 185	135 / 135 / 185
Note	

Ordering data

Screw connection

Type	Qty.	Order No.
CP NT 264W 24V 11A	1	8575310000

Type	Qty.	Order No.
CP NT 432W 24V 18A	1	8575320000

Note

Note

Accessories

Note

Note

compactPower 3-phase

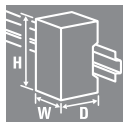

CP NT3 250



CP NT3 400

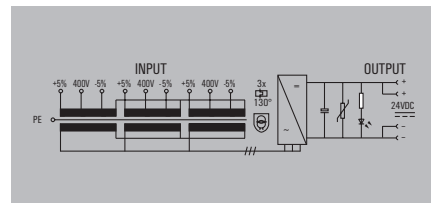
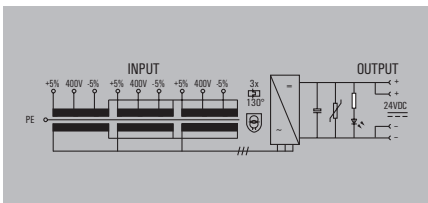

Technical data

Input	
Input voltage	3 x 400 V ±5 %
Input current	0.5 A
Input frequency	50/ 60 Hz
No-load input current	0.1 A
Input fuse	3 x primary thermostatic switch
Ext. Back-up fuse	3 x 1.0 A time-lag
Output	
Output voltage	24 V SELV
Output current at 40°C / 60°C	11 A / 10 A
Output power	250 W
Max. residual ripple	< 2 %
Fuse, max.	External 10 A time-lag
Protective circuit, load side	Varistor
Insulation coordination (EN 50178)	
Electric shock protection	acc. to BGV A3
Insulation strength	4 kV
Insulation class	B
Protection degree	IP 20
Class of protection	I
General data	
Ambient temperature (operational)	-20 °C...+60 °C
Storage temperature	-20 °C...+80 °C
Degree of efficiency at max. load	76%
Installation advice	Direct mounting
Fan signal	No integrated fan
Status indication	Green LED
Weight	4.7 kg
Standards	DIN EN 60950, DIN EN 61558-2-4, -6, 72/23/EWG
EMC standards	EN 61000-6 /2, -3
Approvals	cCSAus; CE

Input	
Input voltage	3 x 400 V ±5 %
Input current	0.75 A
Input frequency	50/ 60 Hz
No-load input current	0.11 A
Input fuse	3 x primary thermostatic switch
Ext. Back-up fuse	3 x 1.2 A time-lag
Output	
Output voltage	24 V SELV
Output current at 40°C / 60°C	18 A / 16 A
Output power	400 W
Max. residual ripple	< 2 %
Fuse, max.	External 16 / 18 A slo-blo
Protective circuit, load side	Varistor
Insulation coordination (EN 50178)	
Electric shock protection	acc. to BGV A3
Insulation strength	4 kV
Insulation class	B
Protection degree	IP 20
Class of protection	I
General data	
Ambient temperature (operational)	-20 °C...+60 °C
Storage temperature	-20 °C...+80 °C
Degree of efficiency at max. load	77%
Installation advice	Direct mounting
Fan signal	No integrated fan
Status indication	Green LED
Weight	6.9 kg
Standards	DIN EN 60950, DIN EN 61558-2-4, -6, 72/23/EWG
EMC standards	EN 61000-6 /2, -3
Approvals	cCSAus; CE

Input	
Input voltage	3 x 400 V ±5 %
Input current	0.75 A
Input frequency	50/ 60 Hz
No-load input current	0.11 A
Input fuse	3 x primary thermostatic switch
Ext. Back-up fuse	3 x 1.2 A time-lag
Output	
Output voltage	24 V SELV
Output current at 40°C / 60°C	18 A / 16 A
Output power	400 W
Max. residual ripple	< 2 %
Fuse, max.	External 16 / 18 A slo-blo
Protective circuit, load side	Varistor
Insulation coordination (EN 50178)	
Electric shock protection	acc. to BGV A3
Insulation strength	4 kV
Insulation class	B
Protection degree	IP 20
Class of protection	I
General data	
Ambient temperature (operational)	-20 °C...+60 °C
Storage temperature	-20 °C...+80 °C
Degree of efficiency at max. load	77%
Installation advice	Direct mounting
Fan signal	No integrated fan
Status indication	Green LED
Weight	6.9 kg
Standards	DIN EN 60950, DIN EN 61558-2-4, -6, 72/23/EWG
EMC standards	EN 61000-6 /2, -3
Approvals	cCSAus; CE

Dimensions	
Clamping range (nominal / min. / max.)	mm ²
Depth x width x height	mm
Note	
Condensation not allowed	

Input	Output
2.5 / 0.5 / 2.5	6 / 0.5 / 6
185 / 84 / 192	185 / 84 / 192
Note	
Condensation not allowed	

Input	Output
2.5 / 0.5 / 2.5	6 / 0.5 / 6
220 / 88 / 213	220 / 88 / 213
Note	
Condensation not allowed	

Ordering data

Screw connection

Type	Qty.	Order No.
CP NT3 250W 24V 10A	1	8628620000

Type	Qty.	Order No.
CP NT3 400W 24V 15A	1	8628630000

Note

Accessories

Note

compactPower

compactPower 3-phase

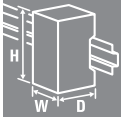

CP NT3 500



CP NT3 600

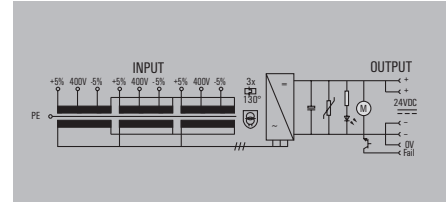
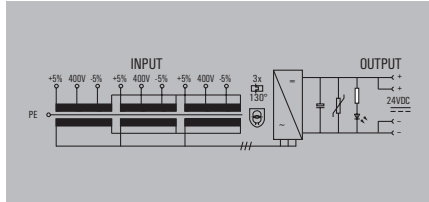

D

Technical data

Input	
Input voltage	3 x 400 V ±5 %
Input current	0.9 A
Input frequency	50/ 60 Hz
No-load input current	0.13 A
Input fuse	3 x primary thermostatic switch
Ext. Back-up fuse	3 x 1.6 A time-lag
Output	
Output voltage	24 V SELV
Output current at 40°C / 60°C	22 A / 20 A
Output power	500 W
Max. residual ripple	< 2 %
Fuse, max.	External 20 / 22 A slo-blo
Protective circuit, load side	Varistor
Insulation coordination (EN 50178)	
Electric shock protection	acc. to BGV A3
Insulation strength	4 kV
Insulation class	B
Protection degree	IP 20
Class of protection	I
General data	
Ambient temperature (operational)	-20 °C...+60 °C
Storage temperature	-20 °C...+80 °C
Degree of efficiency at max. load	78%
Installation advice	Direct mounting
Fan signal	No integrated fan
Status indication	Green LED
Weight	10 kg
Standards	DIN EN 60950, DIN EN 61558-2-4, -6, 72/23/EWG
EMC standards	EN 61000-6 /2, -3
Approvals	cCSAus; CE; cULus

Input	
Input voltage	3 x 400 V ±5 %
Input current	0.9 A
Input frequency	50/ 60 Hz
No-load input current	0.13 A
Input fuse	3 x primary thermostatic switch
Ext. Back-up fuse	3 x 1.6 A time-lag
Output	
Output voltage	24 V SELV
Output current at 40°C / 60°C	22 A / 20 A
Output power	500 W
Max. residual ripple	< 2 %
Fuse, max.	External 20 / 22 A slo-blo
Protective circuit, load side	Varistor
Insulation coordination (EN 50178)	
Electric shock protection	acc. to BGV A3
Insulation strength	4 kV
Insulation class	B
Protection degree	IP 20
Class of protection	I
General data	
Ambient temperature (operational)	-20 °C...+60 °C
Storage temperature	-20 °C...+80 °C
Degree of efficiency at max. load	78%
Installation advice	Direct mounting
Fan signal	No integrated fan
Status indication	Green LED
Weight	10 kg
Standards	DIN EN 60950, DIN EN 61558-2-4, -6, 72/23/EWG
EMC standards	EN 61000-6 /2, -3
Approvals	cCSAus; CE; cULus

Input	
Input voltage	3 x 400 V ±5 %
Input current	1.2 A
Input frequency	50/ 60 Hz
No-load input current	0.15 A
Input fuse	3 x primary thermostatic switch
Ext. Back-up fuse	3 x 2 A time-lag
Output	
Output voltage	24 V SELV
Output current at 40°C / 60°C	26 A / 25 A
Output power	600 W
Max. residual ripple	< 2 %
Fuse, max.	External 25 / 26 A slo-blo
Protective circuit, load side	Varistor
Insulation coordination (EN 50178)	
Electric shock protection	acc. to BGV A3
Insulation strength	4 kV
Insulation class	B
Protection degree	IP 20
Class of protection	I
General data	
Ambient temperature (operational)	-20 °C...+60 °C
Storage temperature	-20 °C...+80 °C
Degree of efficiency at max. load	78%
Installation advice	Direct mounting
Fan signal	Open collector <30 V/ <5 mA during interference
Status indication	Green LED
Weight	11 kg
Standards	DIN EN 60950, DIN EN 61558-2-4, -6, 72/23/EWG
EMC standards	EN 61000-6 /2, -3
Approvals	cCSAus; CE

Dimensions	
Clamping range (nominal / min. / max.)	mm ²
Depth x width x height	mm
Note	
Condensation not allowed	

Input	Output
2.5 / 0.5 / 2.5	6 / 0.5 / 6
220 / 108 / 215	220 / 108 / 215
Note	
Condensation not allowed	

Input	Output
2.5 / 0.5 / 2.5	6 / 0.5 / 6
230 / 108 / 212	230 / 108 / 212
Note	
Condensation not allowed	

Ordering data

Screw connection

Type	Qty.	Order No.
CP NT3 500W 24V 20A	1	8628650000

Type	Qty.	Order No.
CP NT3 600W 24V 25A	1	8628660000

Note

Accessories

Note

Note

Note

Note

compactPower 3-phase

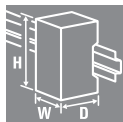

CP NT3 750

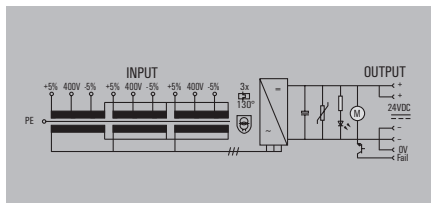

CP NT3 1000

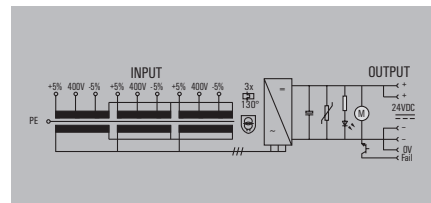

Technical data

Input	
Input voltage	3 x 400 V ±5 %
Input current	1.4 A
Input frequency	50/ 60 Hz
No-load input current	0.16 A
Input fuse	3 x primary thermostatic switch
Ext. Back-up fuse	3 x 2.5 A time-lag
Output	
Output voltage	24 V SELV
Output current at 40°C / 60°C	32 A / 30 A
Output power	750 W
Max. residual ripple	< 2 %
Fuse, max.	External 30 / 32 A slo-blo
Protective circuit, load side	Varistor
Insulation coordination (EN 50178)	
Electric shock protection	acc. to BGV A3
Insulation strength	4 kV
Insulation class	B
Protection degree	IP 20
Class of protection	I
General data	
Ambient temperature (operational)	-20 °C...+60 °C
Storage temperature	-20 °C...+80 °C
Degree of efficiency at max. load	77%
Installation advice	Direct mounting
Fan signal	Open collector <30 V/ <5 mA during interference
Status indication	Green LED
Weight	14 kg
Standards	DIN EN 60950, DIN EN 61558-2-4, -6, 72/23/EWG
EMC standards	EN 61000-6 /2, -3
Approvals	cCSAus; CE

Dimensions	
Clamping range (nominal / min. / max.)	mm ²
Depth x width x height	mm
Note	
Condensation not allowed	

Ordering data

Type	Qty.	Order No.
CP NT3 750W 24V 30A	1	8628670000

Note

Accessories

Note

Input	
Input voltage	3 x 400 V ±5 %
Input current	1.4 A
Input frequency	50/ 60 Hz
No-load input current	0.16 A
Input fuse	3 x primary thermostatic switch
Ext. Back-up fuse	3 x 2.5 A time-lag
Output	
Output voltage	24 V SELV
Output current at 40°C / 60°C	32 A / 30 A
Output power	750 W
Max. residual ripple	< 2 %
Fuse, max.	External 30 / 32 A slo-blo
Protective circuit, load side	Varistor
Insulation coordination (EN 50178)	
Electric shock protection	acc. to BGV A3
Insulation strength	4 kV
Insulation class	B
Protection degree	IP 20
Class of protection	I
General data	
Ambient temperature (operational)	-20 °C...+60 °C
Storage temperature	-20 °C...+80 °C
Degree of efficiency at max. load	77%
Installation advice	Direct mounting
Fan signal	Open collector <30 V/ <5 mA during interference
Status indication	Green LED
Weight	14 kg
Standards	DIN EN 60950, DIN EN 61558-2-4, -6, 72/23/EWG
EMC standards	EN 61000-6 /2, -3
Approvals	cCSAus; CE

Input	Output
2.5 / 0.5 / 2.5	6 / 0.5 / 6
270 / 121 / 255	270 / 121 / 255
Note	
Condensation not allowed	

Type	Qty.	Order No.
CP NT3 750W 24V 30A	1	8628670000

Note

Accessories

Note

Input	
Input voltage	3 x 400 V ±5 %
Input current	1.8 A
Input frequency	50/ 60 Hz
No-load input current	0.14 A
Input fuse	3 x primary thermostatic switch
Ext. Back-up fuse	3 x 3.15 A time-lag
Output	
Output voltage	24 V SELV
Output current at 40°C / 60°C	42 A / 40 A
Output power	1000 W
Max. residual ripple	< 2 %
Fuse, max.	External 40 / 42 A slo-blo
Protective circuit, load side	Varistor
Insulation coordination (EN 50178)	
Electric shock protection	acc. to BGV A3
Insulation strength	4 kV
Insulation class	B
Protection degree	IP 20
Class of protection	I
General data	
Ambient temperature (operational)	-20 °C...+60 °C
Storage temperature	-20 °C...+80 °C
Degree of efficiency at max. load	77%
Installation advice	Direct mounting
Fan signal	Open collector <30 V/ <5 mA during interference
Status indication	Green LED
Weight	18 kg
Standards	DIN EN 60950, DIN EN 61558-2-4, -6, 72/23/EWG
EMC standards	EN 61000-6 /2, -3
Approvals	cCSAus; CE

Input	Output
2.5 / 0.5 / 2.5	10 / 0.5 / 10
280 / 122 / 275	280 / 122 / 275
Note	
Condensation not allowed	

Type	Qty.	Order No.
CP NT3 1000W 24V 40A	1	8628680000

Note

Accessories

Note

Electrical cabinet socket outlet

Electrical cabinet socket outlet

Electrical cabinet socket outlet

E.2

Electrical cabinet socket outlet

Electrical cabinet socket outlet

- Simple installation in electrical cabinet
- TS 35 module can be mounted on rail
- VDE mark of conformity
- Two-pole with earthing contact

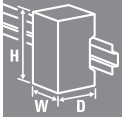

Schuko TS35

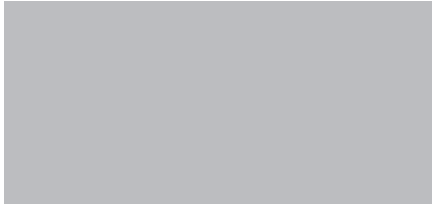
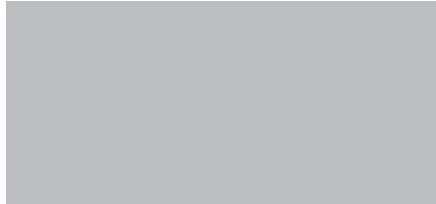

Technical data

Rated voltage
 Rated voltage, max.
 Rated current
 Clamping range, nom.
 Tightening torque
 Ambient temperature (operational)
 Surge voltage category
 Pollution severity
 Protection degree
 Approvals

230 V
 250 V
 16 A
 1 mm²-1.5 mm²
 1.3 Nm
 -20...+40 °C
 II
 2
 CE; GOSTME25; VDE

Dimensions

Clamping range (nominal / min. / max.) mm² 1.5 / 1 / 1.5
 Depth x width x height mm / 76 / 45

Note

Ordering data

Type	Qty.	Order No.
Schuko TS35	10	8734580000

Note

Accessories

Note

Glossary/Technical appendix

Glossary/Technical appendix	Power Supplies - Overview	W.2
	Standards and approvals	W.4
	Glossary	W.6

Power Supplies – Overview

Power supplies are important links in the energy supply chain of automation systems. Unregulated power supplies or regulated switched-mode power supplies are at the heart of every electrical cabinet. 24 V DC has emerged as the standard control voltage for the supply of electrical sub-assemblies and systems. But other control voltages are also required. The correct power supply is a critical factor for the reliable operation of the supplied components. Thus it must be chosen with particular attention.

Power supplies from Weidmüller, whether regulated or unregulated, have proven themselves reliable over many years in the supply of electrical sub-assemblies and systems. They perform reliably and safely – even under harsh industrial conditions – in all sectors of machine construction, industrial automation, and the power and process industries.

Weidmüller offers custom-fit solutions for practically all of your requirements:

- Unregulated transformer power supplies
- Primary switch-mode power supplies
- DC/DC converters
- Diode modules
- UPS control modules
- Electronic fusing

How they work

Unregulated power supply units consist of a mains power transformer that transforms the input voltage into a different AC voltage. The units then make use of a rectifier and a filter circuit to smooth out the DC output voltage.

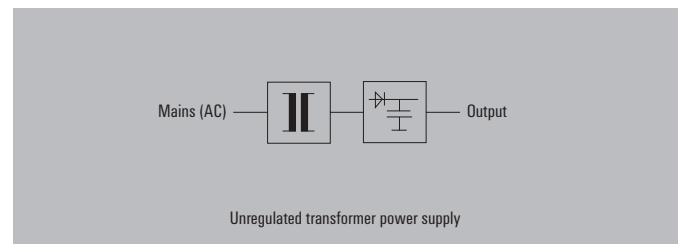

Regulated power supply units in the range up to 1,000 W are usually designed as primary switched-mode power units. The mains AC voltage is then rectified and transformed in high frequency to the secondary side using switching transistors and power transformers. This is followed by the rectifier and filter circuit in order to generate the DC output voltage. A control circuit compares the current and voltage on the output side to the specified target values and then generates a control signal for the switching transistors. This permits compensation for load changes and mains voltage fluctuations. As a result, the output voltage remains stable. These power supply units are increasingly being operated with DC input voltages (for example, Weidmüller's PRO-M line of switched-mode power supplies).

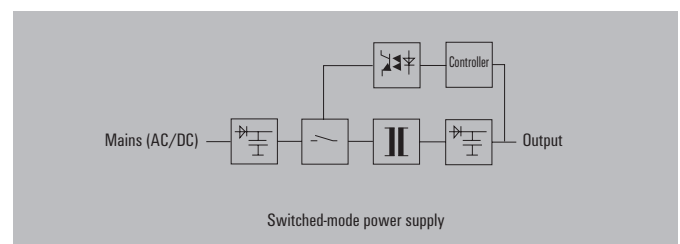

A DC/DC converter is a variation of the classic switched mode power supply. The switching strategy is similar but there is no input rectifier. Starting with a specified DC input voltage, DC/DC converters generate a different DC voltage at a similar or different level. They are used to adapt different voltage levels and also for isolating potentials.

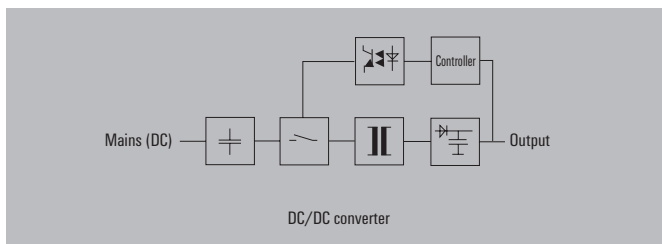

In use around the globe

Weidmüller's power supply units have been designed for use around the world. They can be used in practically all applications throughout the world because of their CE label and many other national and international approvals. Their wide input voltage ranges and compatibility with various mains power connections increases their global appeal.

Temperature range

During operation, power supply units generate power losses. In Weidmüller's switched-mode power supplies, the resulting heat is dispersed using natural air currents only. The design, which does not make use of a ventilation fan, is an example of our uncompromised durability standard. Weidmüller's power supply units, depending on the model, can be used in temperatures ranging from -25 °C to +70 °C.

Compact and efficient design

Weidmüller's switched-mode power supplies are extra small because they take advantage of the above-average degree of efficiency offered by the latest technologies. The power supplies from Weidmüller – whether they are book-shaped with minimised base surface, or variants with reduced height for use in distributor boxes – always provide the proper cost-saving solution.

Standards and approvals

Standard/Approval	Description
DIN EN 50178 (VDE 0160)	Electronic equipment for use in power installations
DIN EN 60950-1 (VDE 0805-1)	IT Equipment – Safety – Part 1: General requirements
DIN EN 61558-1 (VDE 0570-1)	Safety of transformers, power supply units, throttles and similar devices Part 1: General requirements and tests
DIN EN 61558-2-17 (VDE 0570 Part 2-17)	Safety of transformers, power supply units and similar devices Part 2-17: Special requirements for switch-mode power supply transformers
DIN EN 60204-1 (VDE 0113-1)	Safety of machinery – Electrical equipment of machinery – Part 1: General requirements
DIN VDE 0100-410	Construction of power installations with rated voltages up to 1,000 V Part 4: Protective measures Chapter 41: Protection against electrical shock
DIN EN 61204-1	Power supply units for low voltages, with direct-current-output – properties
DIN EN 60947-1	Low-voltage switching devices – Part 1: General definitions
DIN EN 61140	Protection against electrical shock - common requirements for facilities and operating equipment
IEC 38	Supplementary notes relating to status of international standards and European harmonisation of mains voltages 230/400 V
73/23 EWG	Electrical equipment for use within specific voltage limits (Low Voltage Directive)
2004/108/EG (89/336 EWG)	Electromagnetic compatibility (EMC Directive)
2006/42/EG (98/37 EG)	Safety of machines (directive covering mechanical equipment)
UL	Safety approval for the United States market
CSA	Safety approval for the Canadian market
GL	Test specifications for electrical/electronic devices and systems for use in marine technology
UL1310	Class 2 power supplies (limited energy)
UL1604	Electrical equipment for use in dangerous surroundings

Standard/Approval	Description
SEMI F47	Resistance of electronic devices against voltage drops
2006/95/EG (72/23/EWG)	Low Voltage Directive
EN 60721-3-2	Classification of surrounding conditions
EN 60664-1 (VDE0110-1)	Insulation coordination for electrical equipment
C22.2 No. 107.1	General standards for power supplies (Canadian standard)
EN 61000-3-2	Limiting of mains voltage harmonic currents
EN 61000-4-x	Interference immunity tests

Glossary

A

AC/DC converter	Conventional switched-mode power supplies generate a DC voltage from an AC voltage. For this reason they are sometimes also called AC/DC converters. Such devices are increasingly compatible for use with DC input voltages. The primary and secondary sides are typically electrically isolated.
Ambient temperature (operational)	The ambient operating temperature (the min. and max. values) together with the output current and voltage ratings can be used to describe the power capabilities of a power supply unit.

B

Burst	A burst is a quick low-power burst pulse which can, for example, simulate welding equipment phenomena. Similar phenomena can also result from switching operations on the mains supply. This test can be used to demonstrate immunity against quick transients.
--------------	---

C

Class of protection	Electrical equipment is classified according to varying classes of protection. These classes define the particular safety measures that are required to avoid an electrical shock. The most widely used power supplies correspond with protection class I. The basic requirement of protection class I is for a basic insulation and for the earthing of all conductive housing parts. If the basic insulation fails, then the earthed conductive housing serves to prevent an electrical shock. For this reason, devices in protection class I are equipped with an earth (PE) connection.
Connecting power supply units in parallel	Power supplies can only be connected in parallel when this is clearly permitted by the manufacturer. Parallel connections are then normally tied to certain conditions. This is a typical way to increase the output power (for example, when extending a facility). Power supplies are also wired in parallel in order to design in redundant power supply systems. The parallel circuit is not wired straight though but connects using decoupling diodes. → Redundancy
Cooling	Cooling is used by components or devices to prevent them from overheating. A variety of cooling strategies are available – two of the most common are natural and forced-air cooling. Natural (convection-based) cooling takes advantage of the natural air currents. Manufacturers must then ensure that there is sufficient air flow by specifying the clearance gaps and mounting positions that are required above and below the ventilation openings. Forced-air cooling normally uses a fan to dissipate any heat that has been generated. When fans are used in a device, they have the effect of increasing the likelihood of device outages. For this reason, a power supply with natural cooling methods is generally preferred.

D

<p>DC/DC converter</p>	<p>DC/DC converters are switched-mode power supplies that convert a specific DC voltage into another voltage. They are a variant of the AC/DC converter. DC/DC converters, in their simplest implementation, do not isolate voltage potentials. They are used only for adapting voltages. Improved DC/DC converters have isolated voltages. A safety isolating transformer in the power element ensures the required electrical isolation. Besides the voltage adaptation, the isolation of the voltage potentials is an important factor.</p>																																		
<p>Derating</p>	<p>For power supply devices, derating generally refers to the reduction in power as influenced by the surrounding temperature and the input voltage. A temperature derating often occurs starting at a surrounding temperature of 50 °C. The rated power is guaranteed up to this temperature. The available power continually declines as the temperature heats up above this level. This is typically specified in %/K. A voltage-dependent specification is another form of derating For switched-mode power supplies, the derating begins below a specific input voltage. So a switched-mode power supply with a wide input range can typically work under full power with 115 V AC input voltage. However at 85 V AC it can only produce 60 % of the power rating. The coefficient is usually specified in %/V.</p> <div style="display: flex; justify-content: space-around;"> <div data-bbox="624 1115 978 1361"> <p style="text-align: center;">Temperature derating</p> <table border="1"> <caption>Temperature derating data</caption> <thead> <tr> <th>Temperature [°C]</th> <th>Max. current [%IN]</th> </tr> </thead> <tbody> <tr><td>40</td><td>100</td></tr> <tr><td>50</td><td>100</td></tr> <tr><td>60</td><td>100</td></tr> <tr><td>70</td><td>80</td></tr> </tbody> </table> </div> <div data-bbox="1066 1115 1434 1361"> <p style="text-align: center;">Voltage derating</p> <table border="1"> <caption>Voltage derating data</caption> <thead> <tr> <th>Main voltage [V]</th> <th>Max. current [%IN]</th> </tr> </thead> <tbody> <tr><td>70</td><td>60</td></tr> <tr><td>85</td><td>60</td></tr> <tr><td>115</td><td>100</td></tr> <tr><td>130</td><td>100</td></tr> <tr><td>150</td><td>100</td></tr> <tr><td>170</td><td>100</td></tr> <tr><td>190</td><td>100</td></tr> <tr><td>210</td><td>100</td></tr> <tr><td>230</td><td>100</td></tr> <tr><td>250</td><td>100</td></tr> <tr><td>270</td><td>100</td></tr> </tbody> </table> </div> </div>	Temperature [°C]	Max. current [%IN]	40	100	50	100	60	100	70	80	Main voltage [V]	Max. current [%IN]	70	60	85	60	115	100	130	100	150	100	170	100	190	100	210	100	230	100	250	100	270	100
Temperature [°C]	Max. current [%IN]																																		
40	100																																		
50	100																																		
60	100																																		
70	80																																		
Main voltage [V]	Max. current [%IN]																																		
70	60																																		
85	60																																		
115	100																																		
130	100																																		
150	100																																		
170	100																																		
190	100																																		
210	100																																		
230	100																																		
250	100																																		
270	100																																		
<p>Diode modules</p>	<p>Diode modules are used to construct a redundant power supply system. They are important for decoupling the power supply unit. Thus, a short circuit that occurs on the output of a power supply unit will not influence the output voltage.</p>																																		

E

<p>Efficiency</p>	<p>The degree of efficiency is equal to the ratio of output power to input power and is expressed in percent. The degree of efficiency can be between 70 and 90 %, depending on the dimensions and type of technology in use.</p>
<p>EMC (electromagnetic compatibility)</p>	<p>Electromagnetic compatibility describes the interference emissions caused by an electronic device and the level of immunity against external electrical influences. Interference emissions can be caused by cabling and wires or by radiated emissions. Immunity measures the resistance against such wire-based emissions and against radiated emissions such as electrostatic fields and magnetic fields. Electric devices must also be protected against electrostatic discharges.</p>

F

Foldback characteristic curve

The foldback characteristic curve is a special type of output curve that protects the power supply unit from overloads. When a specific current limit is exceeded (for example, by 110 or 120 % of the nominal level), the current is limited electronically and lowered to a very low, safe value. This downward-sloping characteristic curve means that it is not sufficient to simply eliminate the overload. The load must be reduced significantly more so that the adjustment control can return to the normal voltage control. Thus this solution is not suitable for many applications and is becoming less popular.

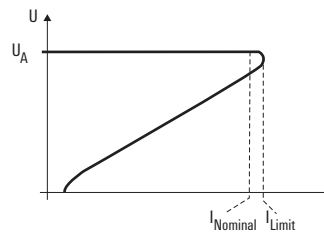

G

Galvanic isolation

Galvanic (electrical) isolation ensures that no electrical connections can exist between the primary and the secondary sides. Opto modules and transformers are the typical components used.

H

Hiccup mode

The hiccup mode is a special output characteristic curve that protects power supply units from overloads and short circuits. The unit switches off at a specified current limit (for example, 110 or 120 % on the nominal rating) and then switches back on after a certain delay. This leads to a pulsating mode of operations which can only revert to continual operations after the overload has been eliminated. The main disadvantage here is that the connected consumer load must be restarted after every pause. A restart may not be possible with motors or large capacitive loads since the restart current peak may once again exceed the defined limit.

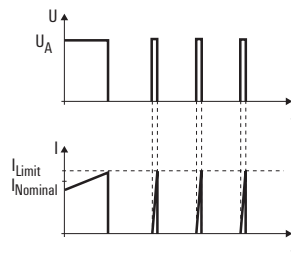

**Hold-up time
(mains-failure bridging time)**

The hold-up time (also known as the mains-failure bridging time) is the interval from the start of the mains outage to the point in time when the output voltage can no longer be maintained at its original level. The hold-up time indicates how long a mains outage may last before it influences the output voltage. For DC power supplies, EN 61204 requires a bridging time of at least 20 ms.

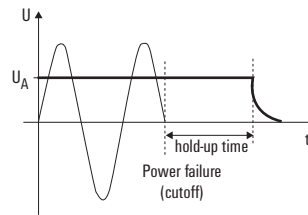

Input voltage range

This refers to the minimum and maximum input voltage at which the rated output specifications can be maintained.

Inrush current

The inrush current refers to the peak current that occurs when turning on a consumer load. Switched-mode power supplies have storage capacitors in the input which can cause significant current peaks while the mains power is being switched on. A variety of circuitry solutions can be used to attenuate these current peaks. In the simplest solution, an inrush limiter is used. Active switching can be used in other cases. The peak current specification indicates which upstream fuse should be used in the circuit. If a fuse is selected which is too sensitive, it can trigger when the mains power is switched on.

IU characteristic curve

The IU characteristic curve is a special output characteristic curve that protects power supply units from overloads and short circuits. It offers the best performance with regards to overload and short circuit capabilities. A current limit is activated at a specific current level (for example, 110 or 120 % on the nominal rating). As the load continues to increase, the output voltage is reduced according to the current limit curve until it reaches a level approaching zero volts. Thus a pulsating mode of operations is avoided for short-term overloads. Large capacitive loads or motors are brought back up along the slope of the current-limit characteristic curve. After a short circuit or overload is fixed, the IU characteristic curve offers the advantage of immediately returning to the normal voltage control mechanism. The full output voltage is then immediately available. The IU characteristic curve is becoming the established standard for modern power supplies. Additional variants are available which pertain to the peak current capacity and the slope of the current-limit characteristic curve.

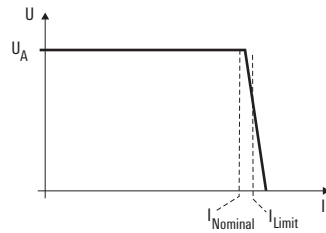

M

Mains harmonics

Power supplies can experience harmonics caused by mains rectification on the input side. These harmonics are multiples of the mains frequencies. Existing standards define specific limit values since such harmonics can significantly lower the mains quality.

Mains system types

This refers to the types of mains supply systems. Systems differ in their method of earthing and the implementation of the phase wire, PE wire and central-point wire. Common mains systems include the TN, IT and TT networks. The individual mains types can also differ in their voltage levels and frequencies.

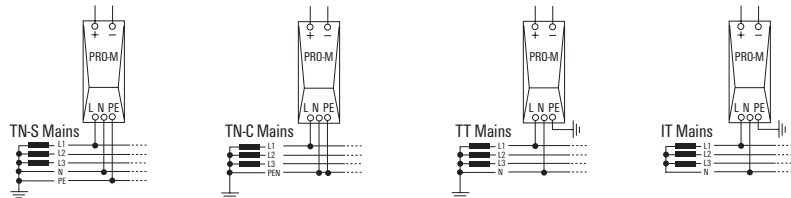

MTBF (mean time between failure)

The MTBF is a statistical value that specifies the probability that a product will fail. It is typically specified in hours and normally assumes a temperature of 25 °C. The probability of failure depends largely on the ambient surroundings. The key variables are the type of load and the ambient temperature.

W

O

Output characteristic curves	<p>The output characteristic curves of power supply devices are determined by current and voltage. Unregulated devices do not have a current limit. In the case of an overload or short circuit, fuses or temperature switches are used to protect the device. Regulated devices are protected against overload and short circuits by means of various output characteristic curves. In this case, the system attempts to prevent any activation of fuses or temperature switches.</p> <p>The mandatory manual reset which follows an overload or short circuit can then be avoided. Common output characteristic curves include the hiccup mode, the foldback characteristic curve or the IU characteristic curve.</p> <p>→ Hiccup mode, foldback characteristic curve, IU characteristic curve</p>
Overvoltage category	<p>Power supply units are classified into overvoltage categories according to the immunity against mains surges and transient voltages.</p>

P

PELV (protective extra-low voltage)	<p>This is a functional DC voltage with secure isolation according to EN 50178. As with SELV, a reinforced or double insulation is used between the primary and secondary sides. However, the secondary side is earthed.</p>
PFC (power factor correction)	<p>The power factor correction can be either passive or active in relation to power supply devices. The reactive power resulting from the bridge rectification puts a significant strain on the power supply network. The relatively poor power efficiency factor that results can be improved by using passive components (such as filters) or an active electronic mechanism. For switched-mode power supplies, PFC usually refers to the active variant of the power factor correction. Power factors of almost 1 can be reached when using an active PFC. Practically no reactive power is drawn from the mains supply network; therefore the strain on the mains network is relatively low.</p>
Pollution severity	<p>Pollution severity describes the environment and ambient conditions that a device requires in order for it to function smoothly. Significant environmental variables include condensation or air containing dust and oil.</p>
Power-boost or boost	<p>The power-boost function is the surge current handling capacity in the seconds to minutes range. This function is often required for starting up DC motors. DC motors have a high start-up current and often require several seconds before they have achieved their rated rotational speed. The power-boost function helps to optimise this start-up phase.</p>
Power factor	<p>The power factor is the ratio of reactive power to apparent power. It is an indicator of the device performance with respect to the load on the mains power network. Depending on the technology in use, the power factor for power supplies can be between 0.45 and nearly 1.</p>

Power loss	For power supply units, the power loss specification indicates the thermal output emitted during nominal (rated) operations. This is a key specification used by engineers when designing the climate control systems within electrical cabinets. It is calculated as the difference between the input and output power and can also take the degree of efficiency into account.
Power rating	The continual output permitted under the rated conditions.
Power supply units connected in series	Power supplies can only be connected in series when this is clearly permitted by the manufacturer. Such series connections are then normally tied to certain conditions. They can be used to increase the output voltage. This is not widely implemented.
Protection degree	According to DIN EN 60529, devices can be classified according to their protection degrees. The numeric code (for example, IP 20) defines two protection degrees: protection against touch or penetration by external objects (the first digit) and protection against water penetration (the second digit). Switched-mode power supplies intended for use in electrical cabinets or similar enclosures are often designed with IP 20 protection. The first digit (in this case, 2) ensures finger protection. The second digit (0) indicates that no protection against water is provided.
Pulsed current capacity	The pulsed current capacity describes the dynamic performance of a switched-mode power supply. Capacitive consumer loads, with their high inrush currents, put a particular strain on a switched-mode power supply. Peak values are reached (in the ms range) which amount to levels many times higher than the mains current. If the current control mechanism reacts too quickly, this can lead to voltage drops and can cause problems for loads which are connected in parallel. For this reason, power supplies are often equipped with a surge current limiting factor based on time. This allows a high current output for only a few ms which can be much higher than the rated current.

R

Rated control voltage	The nominal value of the sparkover voltage for the relay.
Rated input voltage	The input voltage required at which, under the normal mains voltage fluctuations, the output levels can be kept stable. It usually corresponds to the rated voltage for the electric utility's power grid.
Rated output current	The long-term current permitted under the rated conditions.
Rated output voltage	The nominal output voltage used for the rated specifications. It usually corresponds to the factory default output voltage.

Redundancy	A power supply system is considered redundant if it is constructed so that it has partial power supplies which are independent of each other and each of these can individually deliver the output load. When a fault occurs, therefore, it is still possible to continue to supply the connected rated load. In reality, at least two power supplies are connected in parallel using decoupling diodes. In this way, a short circuit in the output of one power supply will not lead to the failure of the entire power supply system. → Diode modules
Regulated power supply units	Switched-mode power supplies, as opposed to more common power supply units, have become established as the standard for the 10–1,000 W power range. They produce a stable output voltage with minimal residual ripple, even when influenced by fluctuations in the mains voltage, mains frequency or load. Their small size and weight is a result of their superior efficiency degree. The electronic control mechanism typically ensures a constant output voltage that varies $\pm 1\%$.
Residual ripple	The residual ripple describes the ratio of superimposed AC voltage to DC voltage on the output side of the power supplies. In addition to a percent specification, the superimposed ripple is often specified in mV_{SS} for switched-mode power supplies.
Resistance to shock	Resistance to shock refers to mechanical immunity against impacts in any direction. This is a key factor while the product is being transported.
Response time	The response time is the time that a power supply unit needs to compensate for a disturbance (for example, a load fluctuation).

S

Switching frequency	Switched-mode power supplies are normally operated with switching frequencies from 20 to 200 kHz. The HF or power transformer is switched on and off using transistors at this switching frequency. Small, compact units can be built with this method in comparison with the traditional 50/60 Hz transformers.
----------------------------	--

Switched-mode power supply units

The switching pulse can be either primary or secondary. Thus there are primary switched-mode and secondary switched-mode power supply units. Secondary switched-mode power supply units are no longer of much significance. The primary switched-mode power supplies are now the focus of attention. The pulse refers to the high-frequency on and off switching of the transformer or transmitter in order to transmit energy. The high frequency allows the use of extra small inductive and capacitive components, particularly for the transmitter. In comparison to transformer-based power supply units, the weight and volume required are much reduced.

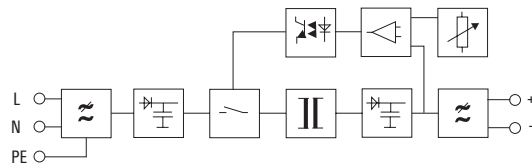
**Selectivity**

When surge protection equipment is connected in series, selectivity refers to the ability of only one upstream fuse to trigger selectively in the event of an overload. The differentiation can take into account current or also time. With DC power supply systems, selectivity refers to the separate fusing of load circuits on the DC side. In this case as well, only the proper series fuse should trigger in the event of an overload. Fuses in DC circuits play a critical role since the power supplies must react to upcoming short circuits with a speedy cut-off or by limiting the current. Usually electronic fuses are used for this purpose.

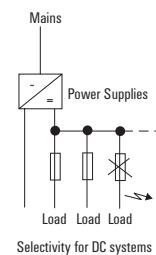
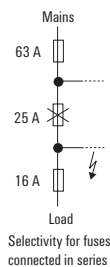
**SELV (safety extra low voltage)**

SELV refers to extra-low safety voltages according to IEC/EN 60950. Reinforced or doubled insulation between the primary and secondary sides is used to prevent electric shock. The output voltage here is sufficiently low so that it does not pose an injury risk if a person comes into direct contact. Earthing on the secondary side is possible but not required.

Surge

A surge is a high-power voltage pulse which can be caused by, for example, a lightning strike. The switching operations from large consumer loads can also generate such voltage surges on the mains network. The surge test is used to demonstrate the immunity against high-power voltage pulses.

T

Temperature range	The temperature range specifies the minimum and maximum ambient temperatures for which a device can start up and run continuously.
--------------------------	--

U

Unregulated power supply units	Unregulated power supplies consist mainly of a transformer, a rectifier and an Elkos filter. Since no controlling system is in place, mains voltage fluctuations influence the DC voltage side. Unregulated power supply units are very sturdy; they can be used in applications where a stabilised DC voltage is not necessary (for example, power supply to contactors).
---------------------------------------	--

V

Vibration resistance	Vibration resistance describes the resistance against constant mechanical vibrations that occur during operations. Rail and ship applications place stricter demands for vibration resistance on the device.
-----------------------------	--

W

Wide-range input	Modern switched-mode power supplies often feature a wide input range. They can be run under a wide range of voltages: from min. to max. rated voltages including the tolerance limits. They do not require any manual range switching.
-------------------------	--

W

Index

Index	Index Type	X.2
	Index Order No.	X.3
	Addresses worldwide	X.4

Type	Order No.	Page
------	-----------	------

C

CP T SNT 70W 12V 6A	1105430000	A.27
CP T SNT 140W 12V 12A	1105440000	A.27
CP T SNT 90W 24V 3,8A	1105790000	A.28
CP T SNT 180W 24V 7,5A	1105810000	A.29
CP T SNT 360W 24V 15A	1105820000	A.29
CP T SNT 600W 24V 25A	1105840000	A.30
CP T SNT 180W 48V 4A	1105850000	A.31
CP T SNT 360W 48V 7,5A	1105860000	A.32
CP T SNT 600W 48V 12,5A	1105870000	A.32
CP T RM 10	1105880000	A.35
CP T RM 20	1105890000	A.35
CP M SNT 250W 24V 10AUW	1165480010	A.23
CP E SNT 100W 5V 16A	1165820000	A.46
CP E SNT 100W 12V 8,5A	1165830000	A.46
CP E SNT 100W 24V 4,5A	1165840000	A.47
CP E SNT 100W 48V 2,3A	1165850000	A.47
CP E SNT 150W 12V 12,5A	1165870000	A.48
CP E SNT 150W 24V 6,5A	1165880000	A.48
CP E SNT 150W 48V 3,3A	1165890000	A.49
CP T SNT2 600 W 24 V 25 A	1194310000	A.34
CP T SNT 90W 24V3,8ACL2	1194410000	A.28
CP T SNT 90W 48V 2A	1194420000	A.31
CP T SNT2 180 W 24 V 7,5 A	1194480000	A.33
CP T SNT2 360 W 24 V 15 A	1194490000	A.33
CP E SNT 50W 24V 2,2A	1202450000	A.43
CP E SNT 50W 48V 1,1A	1202460000	A.43
CP E SNT 75W 5V 12A	1202470000	A.44
CP E SNT 75W 12V 6A	1202480000	A.44
CP E SNT 75W 24V 3,2A	1202490000	A.45
CP E SNT 75W 48V 1,6A	1202510000	A.45
CP E SNT 250W 12V 21A	1202520000	A.50
CP E SNT 250W 24V 10,5A	1202530000	A.50
CP E SNT 250W 48V 5,2A	1202540000	A.51
CP E SNT 350W 24V 14,6A	1202550000	A.52
CP E SNT 350W 48V 7,3A	1202560000	A.52
CP E SNT 50W 12V 4,2A	1202580000	A.42
CP E SNT 50W 5V 10A	1202590000	A.42
CP E SNT 25W 48V 0,57A	1202610000	A.41
CP E SNT 25W 24V 1,1A	1202620000	A.41
CP E SNT 25W 12V 2,1A	1202630000	A.40
CP E SNT 25W 5V 5A	1202640000	A.40
CP M DM20	1222210000	A.70
CP M DM20	1222210010	A.19
CP M DM40	1222220000	A.19
CP M DM40	1222220010	A.19
CP M RM24	1222230000	A.20
CP M CAP	1222240000	A.70
CP M CAP	1222240010	A.21
CP A BATTERY 24V DC3,4AH	1251070000	B.6
CP A BATTERY 24V DC7,2AH	1251080000	B.7
CP A BATTERY 24V DC12AH	1251090000	B.7
CP A BATTERY 24V DC17AH	1251110000	B.7
CP DC BUFFER 24V 20A	1251220000	B.8
CP DCDC 250W 24V 10A	1313320010	A.71
CP DC UPS 24V 40A	1370040010	B.5
CP DC UPS 24V 20A/10A	1370050010	B.5
CP A BATTERY 24V DC1,3AH	1406930000	B.6
CP M SNT 500W 36V 13,5A	1412540010	A.18
CP DC UPS TF05	1444480000	B.9
CP DC UPS TF25	1444540000	B.9
CP A WALLADAPTER 45MM	1461850000	B.9
CP A WALLADAPTER 30 MM	1461870000	B.9
CP NT 36W 24V 1,5A	8575260000	D.4
CP NT 72W 24V 3A	8575270000	D.4
CP NT 144W 24V 6A	8575280000	D.5
CP NT 192W 24V 8A	8575300000	D.5
CP NT 264W 24V 11A	8575310000	D.6
CP NT 432W 24V 18A	8575320000	D.6
CP NT3 250W 24V 10A	8628620000	D.7
CP NT3 400W 24V 15A	8628630000	D.7
CP NT3 500W 24V 20A	8628650000	D.8
CP NT3 600W 24V 25A	8628660000	D.8
CP NT3 750W 24V 30A	8628670000	D.9
CP NT3 1000W 24V 40A	8628680000	D.9
CP DM 10	8710620000	A.10
CP SNT 48W 24V 2A	8739140000	A.61
CP SNT 25W 5V 5A	8754960000	A.59
CP SNT 48W 12V 4A	8754970000	A.60
CP DM 20	8768650000	A.10
CP SNT 48W 48V 1A	8879230000	A.62
CP M SNT 70W 24V 3A	8951330000	A.13
CP M SNT 70W 24V 3A	8951330010	A.13
CP M SNT 120W 24V 5A	8951340000	A.13
CP M SNT 120W 24V 5A	8951340010	A.13
CP M SNT 180W 24V 7,5A	8951350000	A.14
CP M SNT 180W 24V 7,5A	8951350010	A.14
CP M SNT 250W 24V 10A	8951360000	A.14
CP M SNT 250W 24V 10A	8951360010	A.14
CP M SNT 500W 24V 20A	8951370000	A.15
CP M SNT 500W 24V 20A	8951370010	A.15
CP M SNT 1000W 24V 40A	8951380000	A.15
CP M SNT 1000W 24V 40A	8951380010	A.15
CP M SNT3 120W 24V 5A	8951390000	A.16
CP M SNT3 120W 24V 5A	8951390010	A.16
CP M SNT3 250W 24V 10A	8951400000	A.16
CP M SNT3 250W 24V 10A	8951400010	A.16
CP M SNT3 500W 24V 20A	8951410000	A.17

Type	Order No.	Page
------	-----------	------

CP M SNT3 500W 24V 20A	8951410010	A.17
CP M SNT3 1000W 24V 40A	8951420000	A.17
CP M SNT3 1000W 24V 40A	8951420010	A.17
CP SNT 12W 24V 0,5A	9918840024	A.64
CP DCDC 50W 12V 3A	9919371212	A.66
CP DCDC 50W 15V 3A	9919371215	A.67
CP DCDC 50W 22-24V 2A	9919371224	A.67
CP DCDC 50W 5V 8A	9919372405	A.68
CP DCDC 50W 12V 3A	9919372412	A.67
CP DCDC 50W 15V 3A	9919372415	A.68
CP DCDC 50W 22-24V 2A	9919372424	A.66
CP SNT 24W 5V 2A	9928890005	A.58
CP SNT 24W 12V 1,5A	9928890012	A.57
CP SNT 24W 15V 1,5A	9928890015	A.57
CP SNT 24W 24V 1A	9928890024	A.56
CP SNT 24W 28V 1A	9928890028	A.56

M

MTA 30 BK	1168970000	B.9
MTA 45 MF	1251310000	B.9
MTA 30 MF	1251320000	B.9
MTA 45 BK	1962250000	B.9

P

PRO ECO 72W 24V 3A	1469470000	A.5
PRO ECO 120W 24V 5A	1469480000	A.5
PRO ECO 240W 24V 10A	1469490000	A.6
PRO ECO 480W 24V 20A	1469510000	A.6
PRO ECO 960W 24V 40A	1469520000	A.7
PRO ECO3 120W 24V 5A	1469530000	A.8
PRO ECO3 240W 24V 10A	1469540000	A.8
PRO ECO3 480W 24V 20A	1469550000	A.9
PRO ECO3 960W 24V 40A	1469560000	A.9

S

SM 18/9,5 K MC NE WS	1248580000	B.9
Schuko TS35	8734580000	E.2
SDIS 0,5X3,0X100	9008380000	B.9
SDIS 1,0X5,5X125	9008410000	B.9
SDIK PH1	9008570000	A.63
SDIK PH2	9008580000	A.36

W

WEW 35/1 SW	1162600000	B.9
WGS 24Vdc 1,6A	8618890000	C.4
WGS 24Vdc 3,15A	8618910000	C.4
WGS 24Vdc 6,3A	8618930000	C.5
WGS 24Vdc 8,0A	8618940000	C.5
WGZ 24VDC 8,0A	8621010000	C.5
WGZ 24Vdc 6,3A	8621020000	C.5
WGZ 24Vdc 3,15A	8621030000	C.4
WGZ 24Vdc 1,6A	8621040000	C.4
WGS 24Vdc 0,5...5A	8710270000	C.6
WGZ 24Vdc 0,5...5A	8727630000	C.6

Order No.	Type	Page
-----------	------	------

1100000000

1105430000	CP T SNT 70W 12V 6A	A.27
1105440000	CP T SNT 140W 12V 12A	A.27
1105790000	CP T SNT 90W 24V 3,8A	A.28
1105810000	CP T SNT 180W 24V 7,5A	A.29
1105820000	CP T SNT 360W 24V 15A	A.29
1105840000	CP T SNT 600W 24V 25A	A.30
1105850000	CP T SNT 180W 48V 4A	A.31
1105860000	CP T SNT 360W 48V 7,5A	A.32
1105870000	CP T SNT 600W 48V 12,5A	A.32
1105880000	CP T RM 10	A.35
1105890000	CP T RM 20	A.35

1160000000

1162600000	WEW 35/1 SW	B.9
1165480010	CP M SNT 250W 24V 10AUW	A.23
1165820000	CP E SNT 100W 5V 16A	A.46
1165830000	CP E SNT 100W 12V 8,5A	A.46
1165840000	CP E SNT 100W 24V 4,5A	A.47
1165850000	CP E SNT 100W 48V 2,3A	A.47
1165870000	CP E SNT 150W 12V 12,5A	A.48
1165880000	CP E SNT 150W 24V 6,5A	A.48
1165890000	CP E SNT 150W 48V 3,3A	A.49
1168970000	MTA 30 BK	B.9

1190000000

1194310000	CP T SNT2 600 W 24 V 25 A	A.34
1194410000	CP T SNT 90W 24V3,8ACL2	A.28
1194420000	CP T SNT 90W 48V 2A	A.31
1194480000	CP T SNT2 180 W 24 V 7,5 A	A.33
1194490000	CP T SNT2 360 W 24 V 15 A	A.33

1200000000

1202450000	CP E SNT 50W 24V 2,2A	A.43
1202460000	CP E SNT 50W 48V 1,1A	A.43
1202470000	CP E SNT 75W 5V 12A	A.44
1202480000	CP E SNT 75W 12V 6A	A.44
1202490000	CP E SNT 75W 24V 3,2A	A.45
1202510000	CP E SNT 75W 48V 1,6A	A.45
1202520000	CP E SNT 250W 12V 2,1A	A.50
1202530000	CP E SNT 250W 24V 10,5A	A.50
1202540000	CP E SNT 250W 48V 5,2A	A.51
1202550000	CP E SNT 350W 24V 14,6A	A.52
1202560000	CP E SNT 350W 48V 7,3A	A.52
1202580000	CP E SNT 50W 12V 4,2A	A.42
1202590000	CP E SNT 50W 5V 10A	A.42
1202610000	CP E SNT 25W 48V 0,57A	A.41
1202620000	CP E SNT 25W 24V 1,1A	A.41
1202630000	CP E SNT 25W 12V 2,1A	A.40
1202640000	CP E SNT 25W 5V 5A	A.40

1220000000

1222210000	CP M DM20	A.70
1222210010	CP M DM20	A.19
1222220000	CP M DM40	A.19
1222220010	CP M DM40	A.19
1222230000	CP M RM24	A.20
1222240000	CP M CAP	A.70
1222240010	CP M CAP	A.21

1240000000

1248580000	SM 18/9,5 K MC NE WS	B.9
------------	----------------------	-----

1250000000

1251070000	CP A BATTERY 24V DC3.4AH	B.6
1251080000	CP A BATTERY 24V DC7.2AH	B.7
1251090000	CP A BATTERY 24V DC12AH	B.7
1251110000	CP A BATTERY 24V DC17AH	B.7
1251220000	CP DC BUFFER 24V 20A	B.8
1251310000	MTA 45 MF	B.9
1251320000	MTA 30 MF	B.9

1310000000

1313320010	CP DCDC 250W 24V 10A	A.71
------------	----------------------	------

1370000000

1370040010	CP DC UPS 24V 40A	B.5
1370050010	CP DC UPS 24V 20A/10A	B.5

1400000000

1406930000	CP A BATTERY 24V DC1.3AH	B.6
------------	--------------------------	-----

1410000000

1412540010	CP M SNT 500W 36V 13,5A	A.18
------------	-------------------------	------

Order No.	Type	Page
-----------	------	------

1440000000

1444480000	CP DC UPS TF05	B.9
1444540000	CP DC UPS TF25	B.9

1460000000

1461850000	CP A WALLADAPTER 45MM	B.9
1461870000	CP A WALLADAPTER 30 MM	B.9
1469470000	PRO ECO 72W 24V 3A	A.5
1469480000	PRO ECO 120W 24V 5A	A.5
1469490000	PRO ECO 240W 24V 10A	A.6
1469510000	PRO ECO 480W 24V 20A	A.6
1469520000	PRO ECO 960W 24V 40A	A.7
1469530000	PRO ECO3 120W 24V 5A	A.8
1469540000	PRO ECO3 240W 24V 10A	A.8
1469550000	PRO ECO3 480W 24V 20A	A.9
1469560000	PRO ECO3 960W 24V 40A	A.9

1960000000

1962250000	MTA 45 BK	B.9
------------	-----------	-----

8570000000

8575260000	CP NT 36W 24V 1,5A	D.4
8575270000	CP NT 72W 24V 3A	D.4
8575280000	CP NT 144W 24V 6A	D.5
8575300000	CP NT 192W 24V 8A	D.5
8575310000	CP NT 264W 24V 11A	D.6
8575320000	CP NT 432W 24V 18A	D.6

8610000000

8618890000	WGS 24Vdc 1,6A	C.4
8618910000	WGS 24Vdc 3,15A	C.4
8618930000	WGS 24Vdc 6,3A	C.5
8618940000	WGS 24Vdc 8,0A	C.5

8620000000

8621010000	WGZ 24VDC 8,0A	C.5
8621020000	WGZ 24Vdc 6,3A	C.5
8621030000	WGZ 24Vdc 3,15A	C.4
8621040000	WGZ 24Vdc 1,6A	C.4
8628620000	CP NT3 250W 24V 10A	D.7
8628630000	CP NT3 400W 24V 15A	D.7
8628650000	CP NT3 500W 24V 20A	D.8
8628660000	CP NT3 600W 24V 25A	D.8
8628670000	CP NT3 750W 24V 30A	D.9
8628680000	CP NT3 1000W 24V 40A	D.9

8710000000

8710270000	WGS 24Vdc 0,5...5A	C.6
8710620000	CP DM 10	A.10

8720000000

8727630000	WGZ 24Vdc 0,5...5A	C.6
------------	--------------------	-----

8730000000

8734580000	Schuko TS35	E.2
8739140000	CP SNT 48W 24V 2A	A.61

8750000000

8754960000	CP SNT 25W 5V 5A	A.59
8754970000	CP SNT 48W 12V 4A	A.60

8760000000

8768650000	CP DM 20	A.10
------------	----------	------

8870000000

8879230000	CP SNT 48W 48V 1A	A.62
------------	-------------------	------

8950000000

8951330000	CP M SNT 70W 24V 3A	A.13
8951330010	CP M SNT 70W 24V 3A	A.13
8951340000	CP M SNT 120W 24V 5A	A.13
8951340010	CP M SNT 120W 24V 5A	A.13
8951350000	CP M SNT 180W 24V 7,5A	A.14
8951350010	CP M SNT 180W 24V 7,5A	A.14
8951360000	CP M SNT 250W 24V 10A	A.14
8951360010	CP M SNT 250W 24V 10A	A.14
8951370000	CP M SNT 500W 24V 20A	A.15
8951370010	CP M SNT 500W 24V 20A	A.15
8951380000	CP M SNT 1000W 24V 40A	A.15
8951380010	CP M SNT 1000W 24V 40A	A.15
8951390000	CP M SNT3 120W 24V 5A	A.16
8951390010	CP M SNT3 120W 24V 5A	A.16
8951400000	CP M SNT3 250W 24V 10A	A.16
8951400010	CP M SNT3 250W 24V 10A	A.16
8951410000	CP M SNT3 500W 24V 20A	A.17
8951410010	CP M SNT3 500W 24V 20A	A.17

Order No.	Type	Page
-----------	------	------

8951420000	CP M SNT3 1000W 24V 40A	A.17
8951420010	CP M SNT3 1000W 24V 40A	A.17

9000000000

9008380000	SDIS 0.5X3.0X100	B.9
9008410000	SDIS 1.0X5.5X125	B.9
9008570000	SDIK PH1	A.63
9008580000	SDIK PH2	A.36

9910000000

9918840024	CP SNT 12W 24V 0,5A	A.64
9919371212	CP DCDC 50W 12V 3A	A.66
9919371215	CP DCDC 50W 15V 3A	A.67
9919371224	CP DCDC 50W 22-24V 2A	A.67
9919372405	CP DCDC 50W 5V 8A	A.68
9919372412	CP DCDC 50W 12V 3A	A.67
9919372415	CP DCDC 50W 15V 3A	A.68
9919372424	CP DCDC 50W 22-24V 2A	A.66

9920000000

9928890005	CP SNT 24W 5V 2A	A.58
9928890012	CP SNT 24W 12V 1,5A	A.57
9928890015	CP SNT 24W 15V 1,5A	A.57
9928890024	CP SNT 24W 24V 1A	A.56
9928890028	CP SNT 24W 28V 1A	A.56

We cannot guarantee that there are no mistakes in the publications or software provided by us to the customer for the purpose of making orders. We try our best to quickly correct errors in our printed media.

X

All orders are based on our general terms of delivery, which can be reviewed on the websites of our group companies where you place your order. On demand we can also send the general terms of delivery to you.

Weidmüller – Your partner in Industrial Connectivity

As experienced experts we support our customers and partners around the world with products, solutions and services in the industrial environment of power, signal and data. We are at home in their industries and markets and know the technological challenges of tomorrow. We are therefore continuously developing innovative, sustainable and useful solutions for their individual needs. Together we set standards in Industrial Connectivity.

Weidmüller Interface GmbH & Co. KG
Klingenbergstraße 16
32758 Detmold, Germany
T +49 5231 14-0
F +49 5231 14-292083
info@weidmueller.com
www.weidmueller.com

Your local Weidmüller partner can
be found on our website:
www.weidmueller.com/countries

Made in Germany



Order number: 1460790000/10/2013/SMDM